

Размер 50  
рост 168 см

Соответствие размеров  
смотрите на сайте  
«Шкатулка»  
<http://materials.tell4all.ru>

Файл с выкройкой и все его фрагменты охраняются  
**законом об авторском праве**. Публикация и распространение  
выкройки и ее фрагментов запрещены!  
Официальное разрешение предоставлено только следующим  
сайтам:  
<http://materials.tell4all.ru>  
Если Вы обнаружили нарушение авторских прав,  
необходимо сообщить об этом по адресу [admin@tell4all.ru](mailto:admin@tell4all.ru)

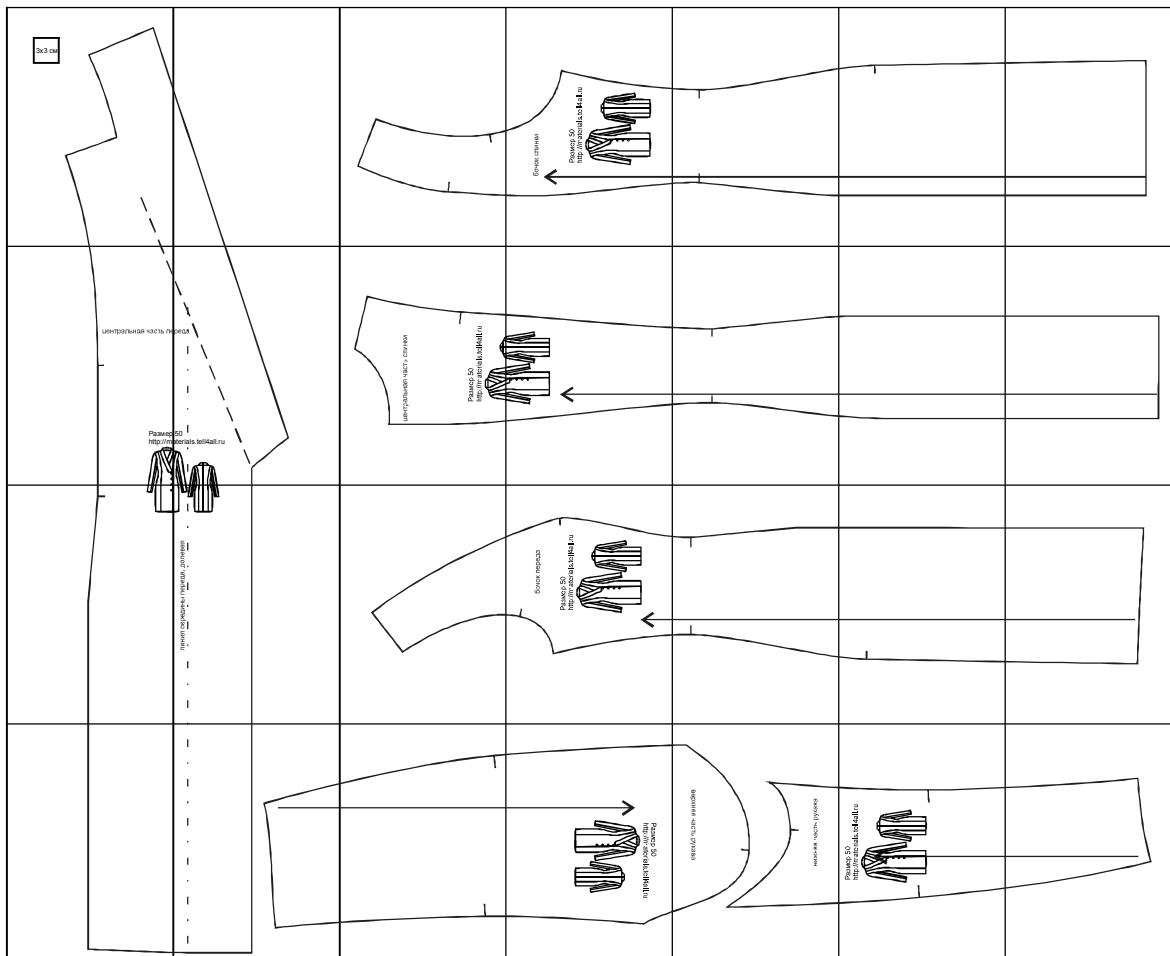

(1, 1)

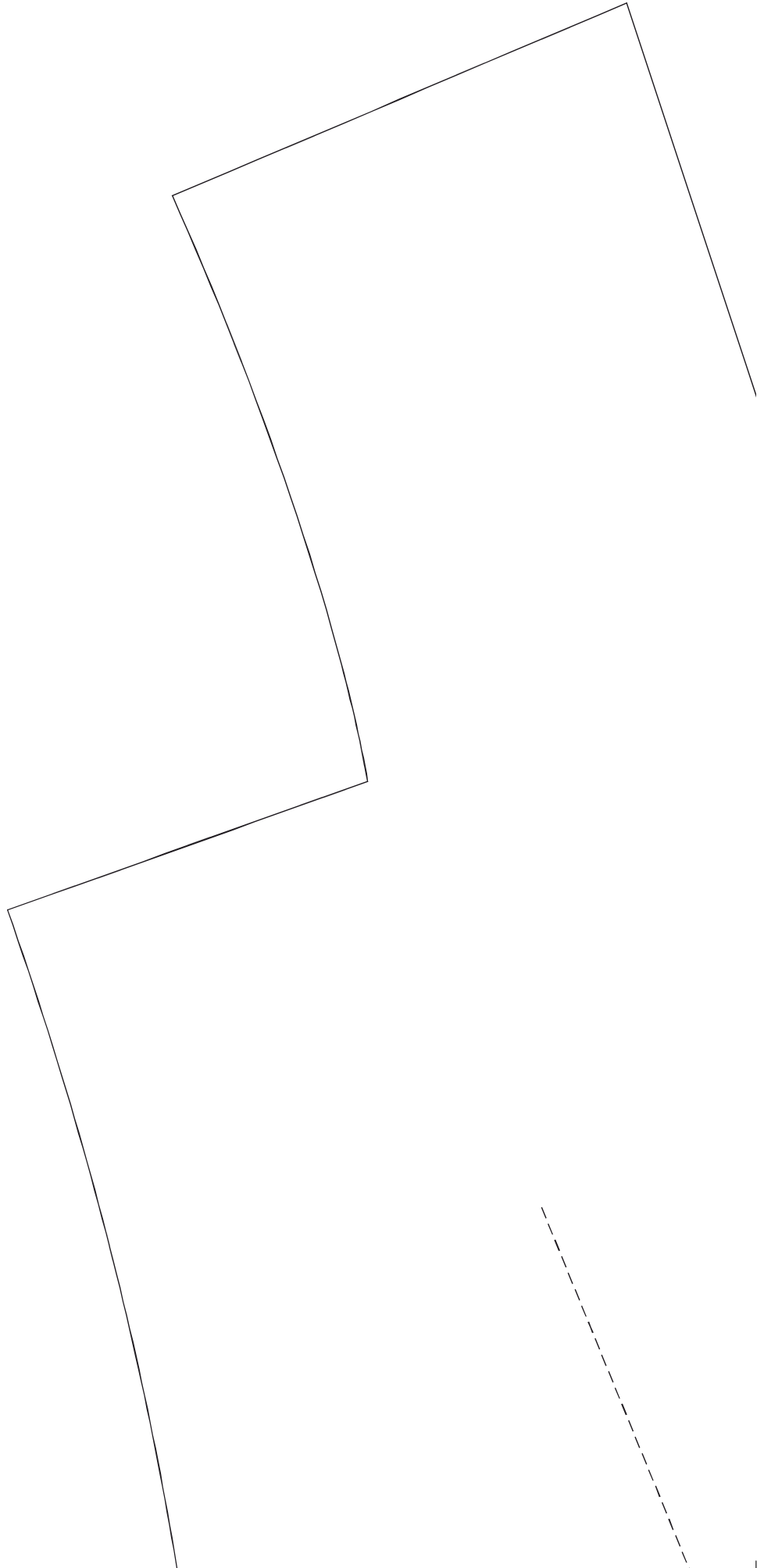
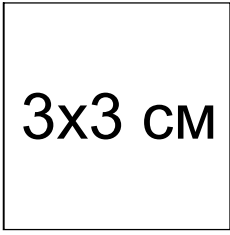

(2, 1)

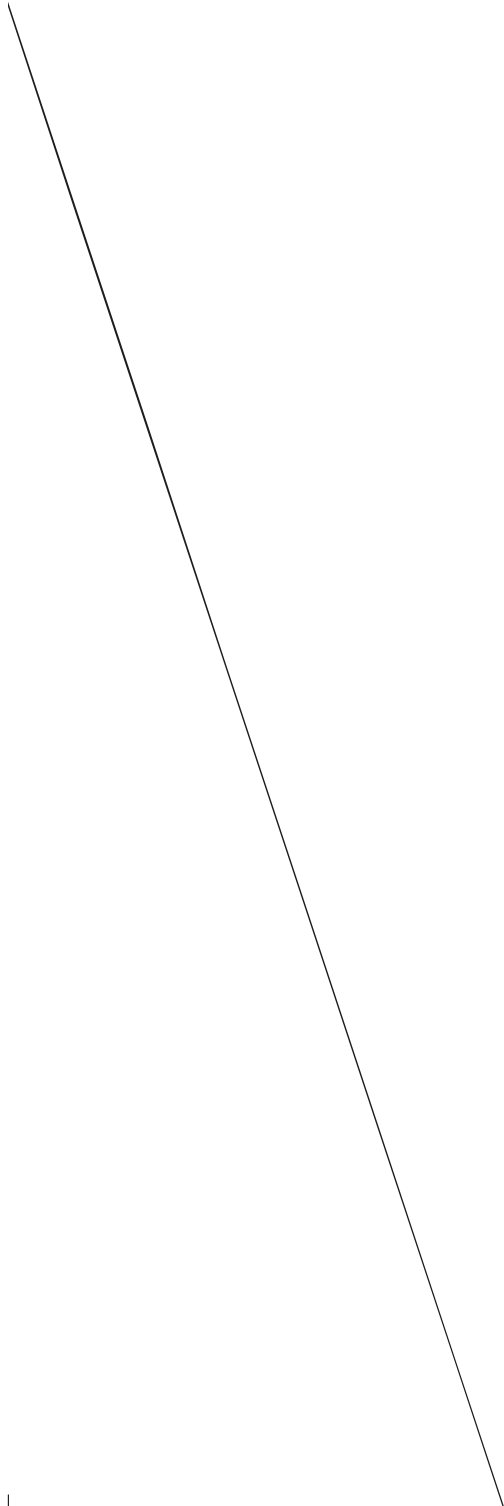

(3, 1)

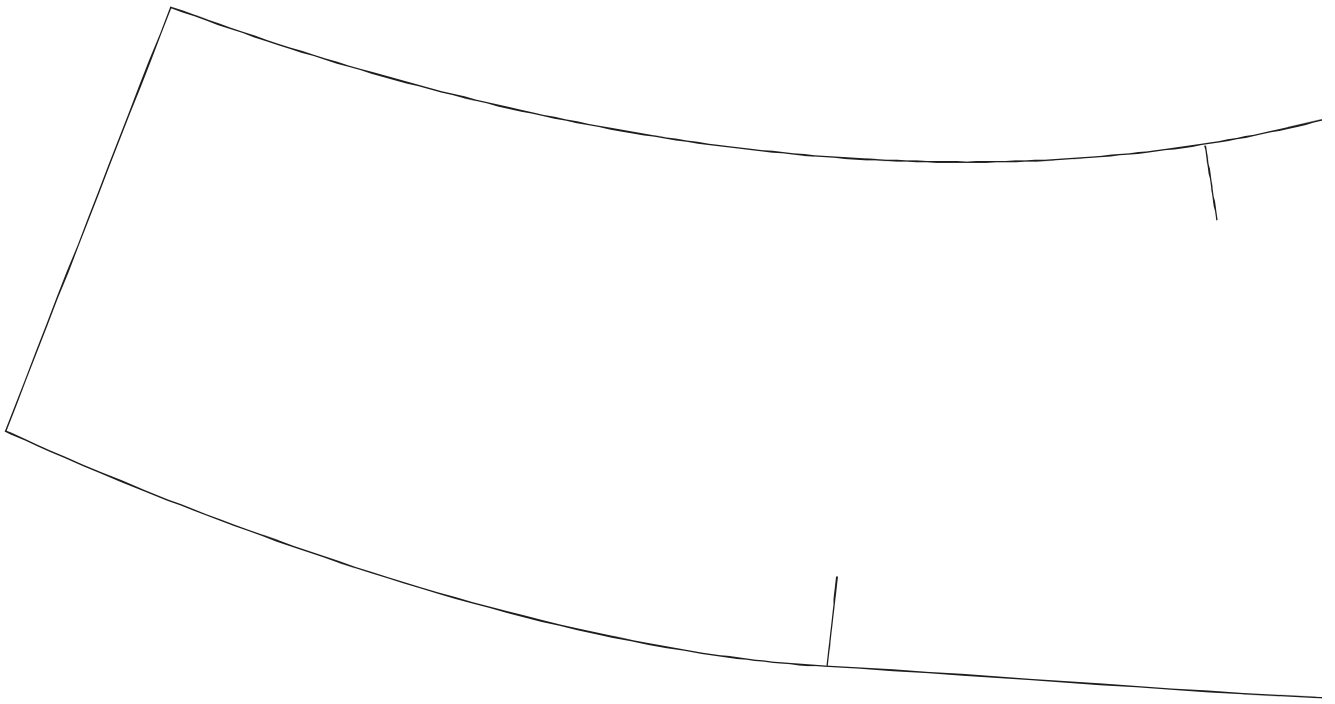

# БОЧОК СПИНКИ

Размер 50  
<http://materials.tell4all.ru>

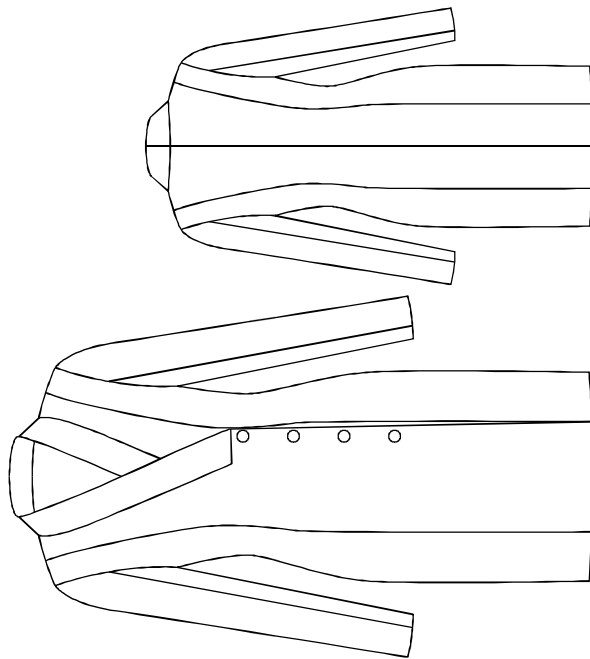

(5, 1)

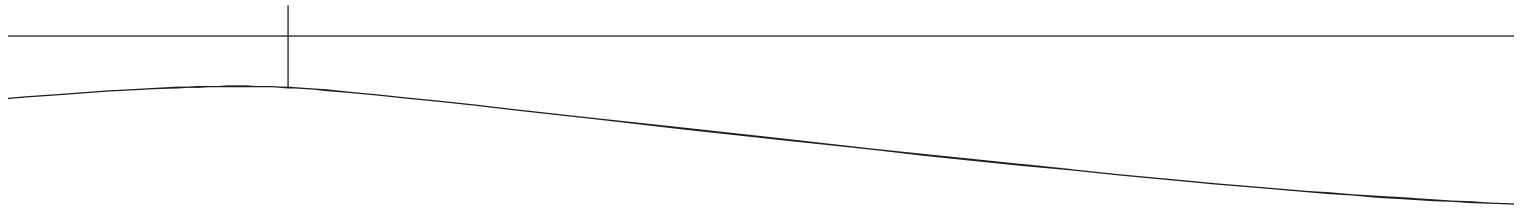
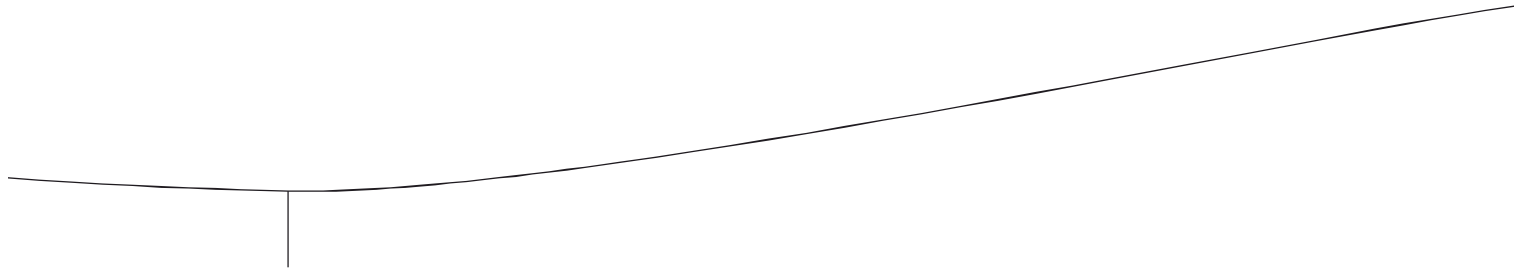

(6, 1)



⊥ (7, 1)

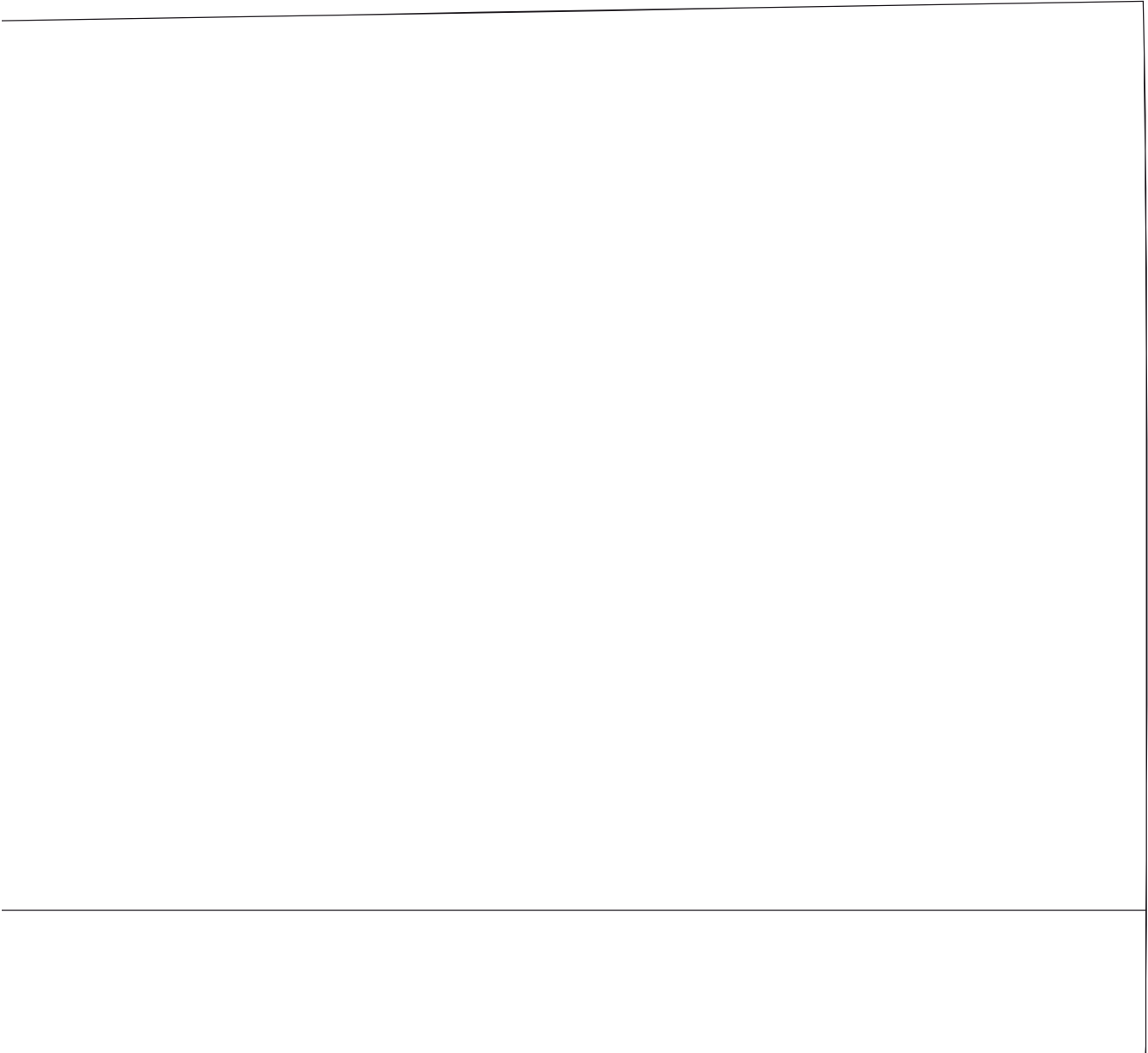

+

⊥



центральная часть п

Размер  
<http://m>

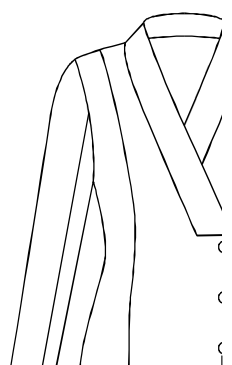

эреда

50  
materials.tell4all.ru

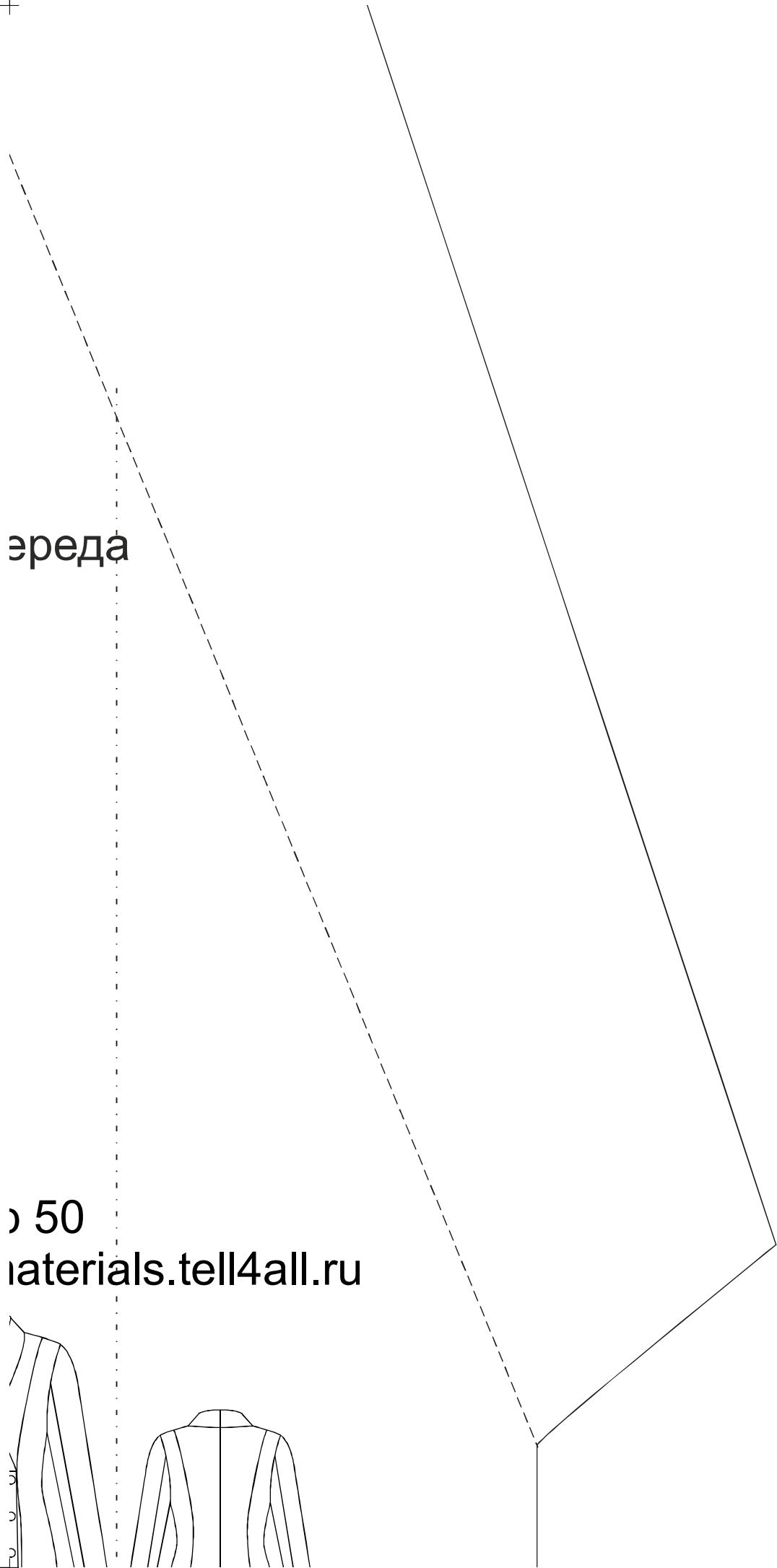
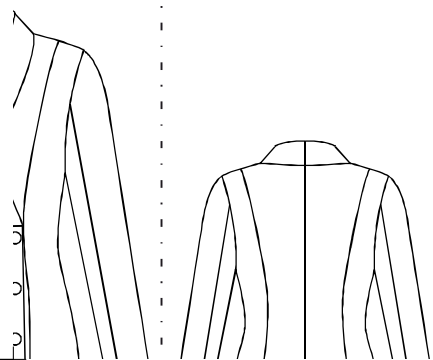

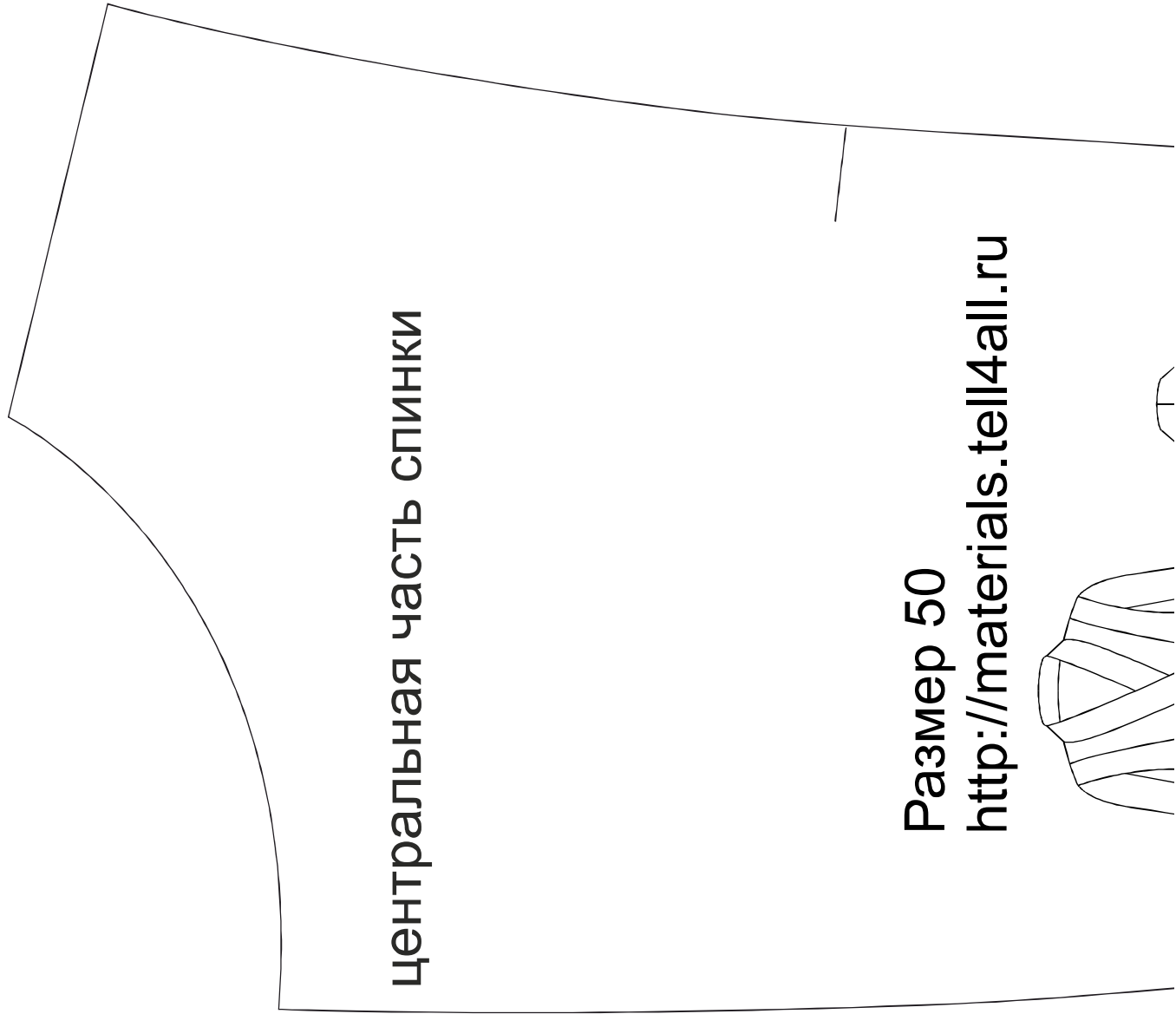

центральная часть СПИНКИ

Размер 50

<http://materials.tell4all.ru>

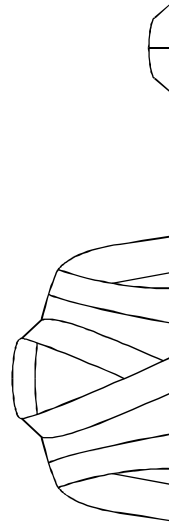

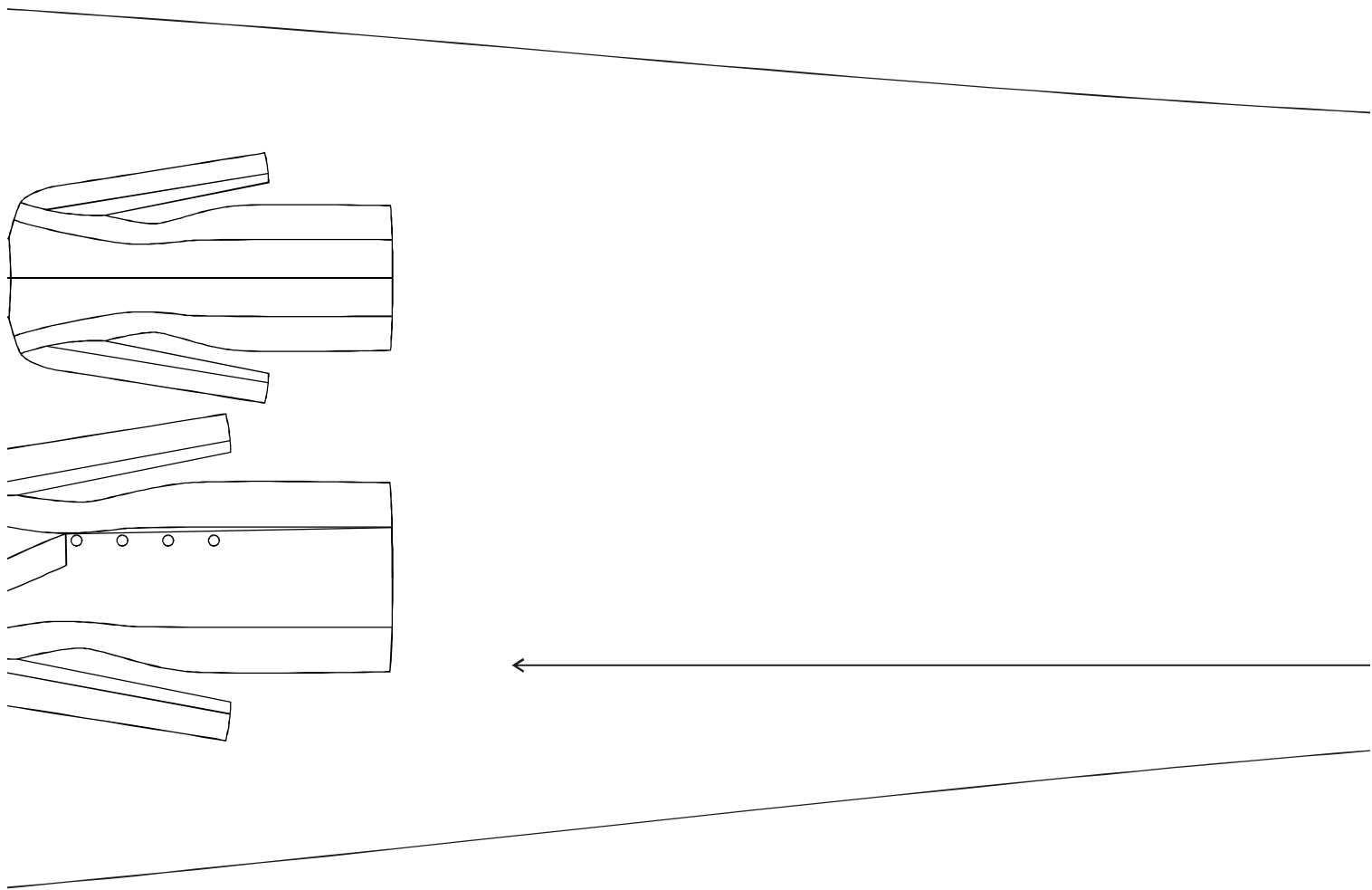

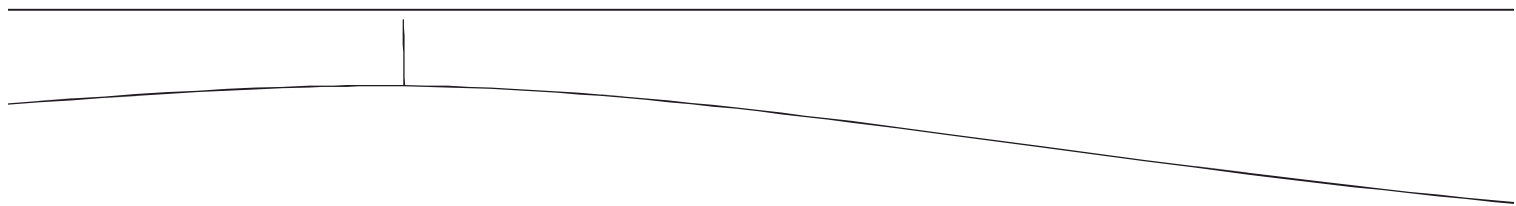
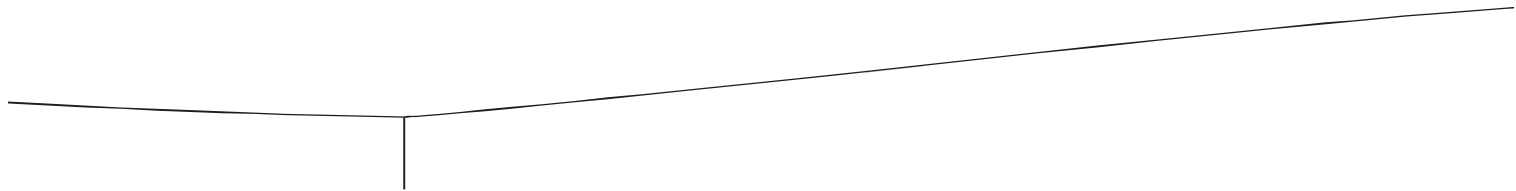



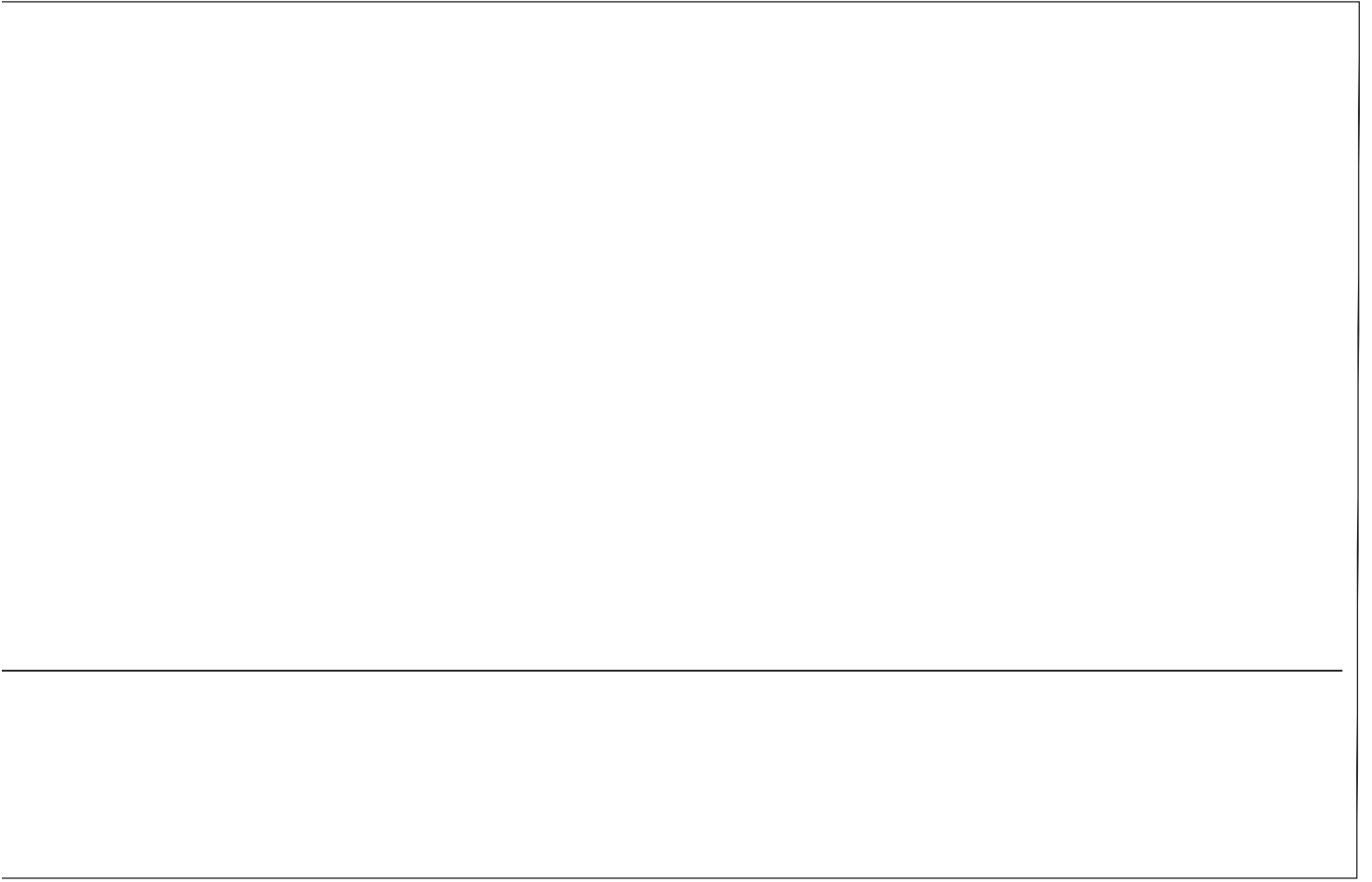

— (1, 3)

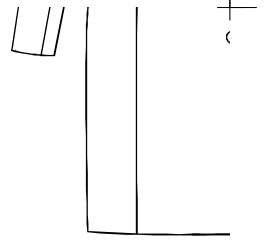

—

—



ЛИНИЯ СЕРЕДИНЫ ПЕРЕДА, ДОЛЕВАЯ

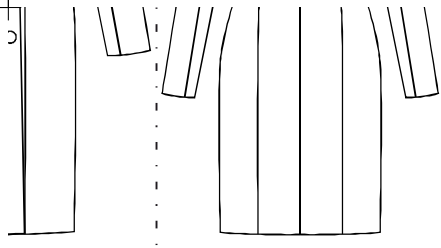

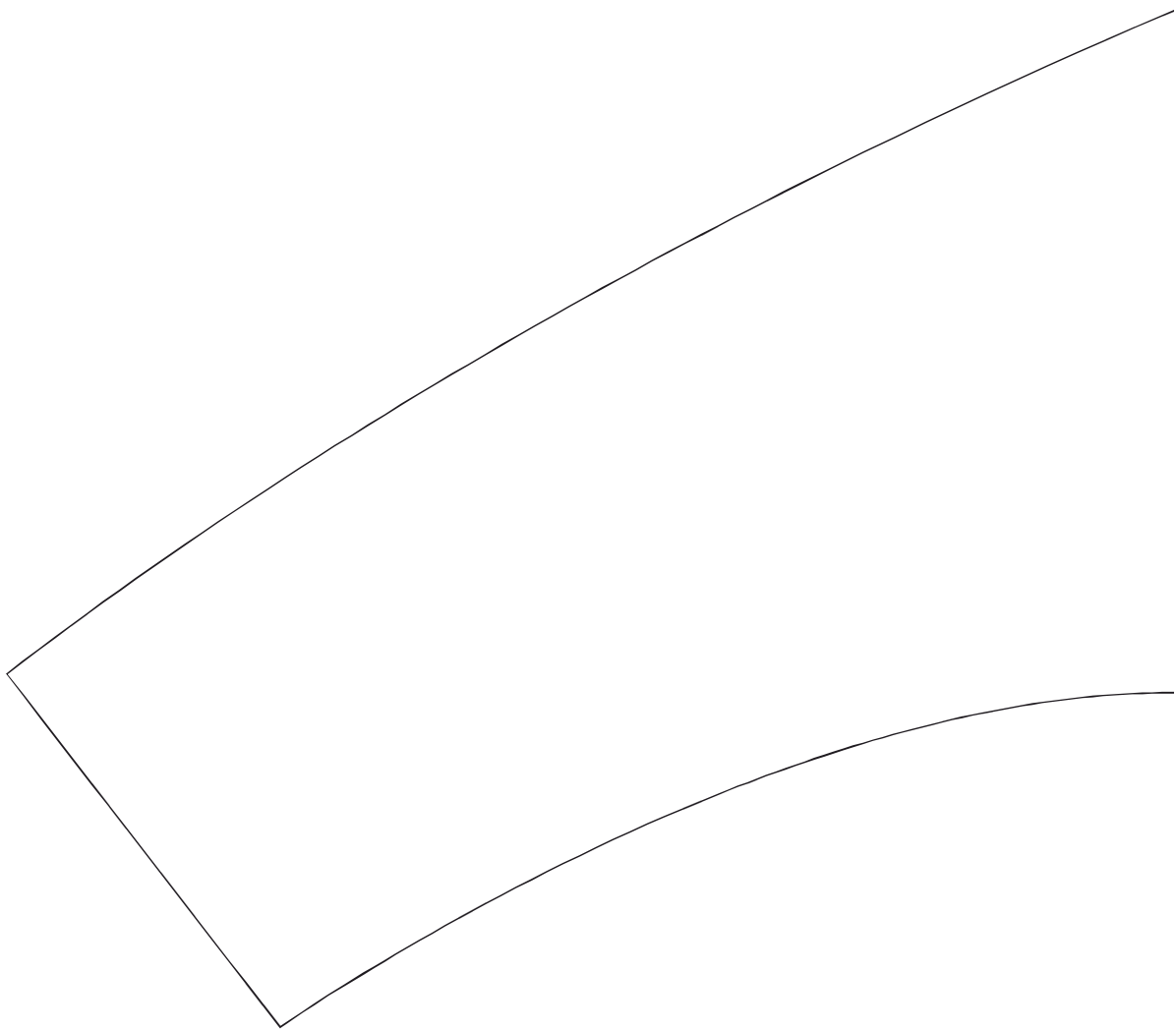

бочок переда

Размер 50  
<http://materials.tell4all.ru>

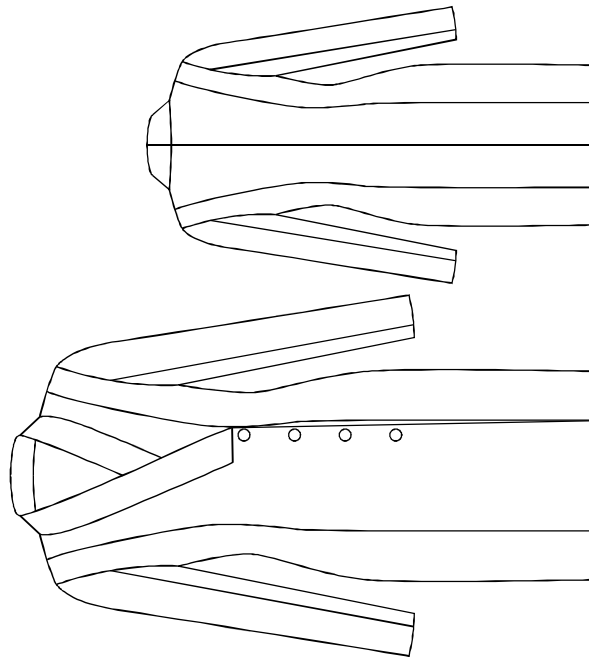

(5, 3)

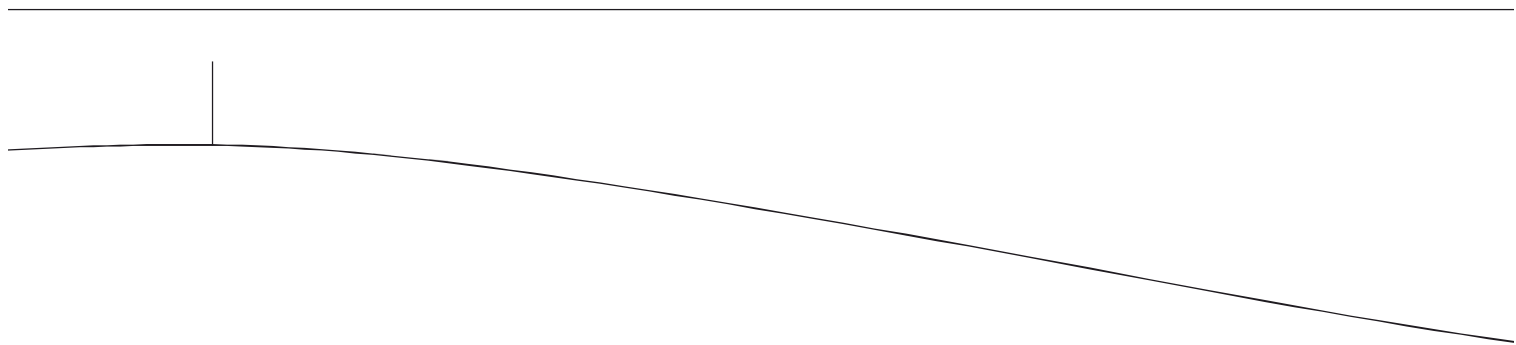
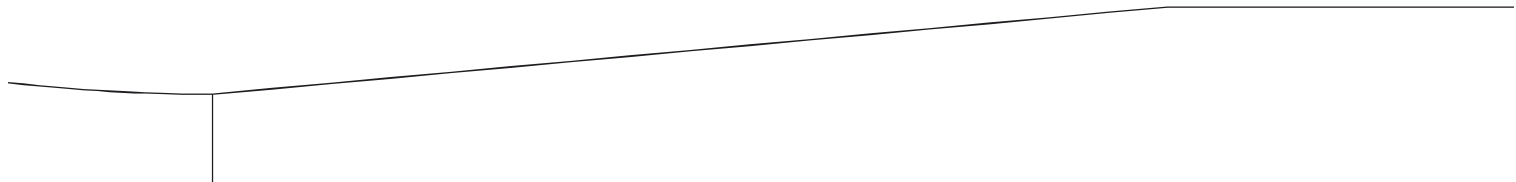





— (1, 4)

+



+

(2, 4)

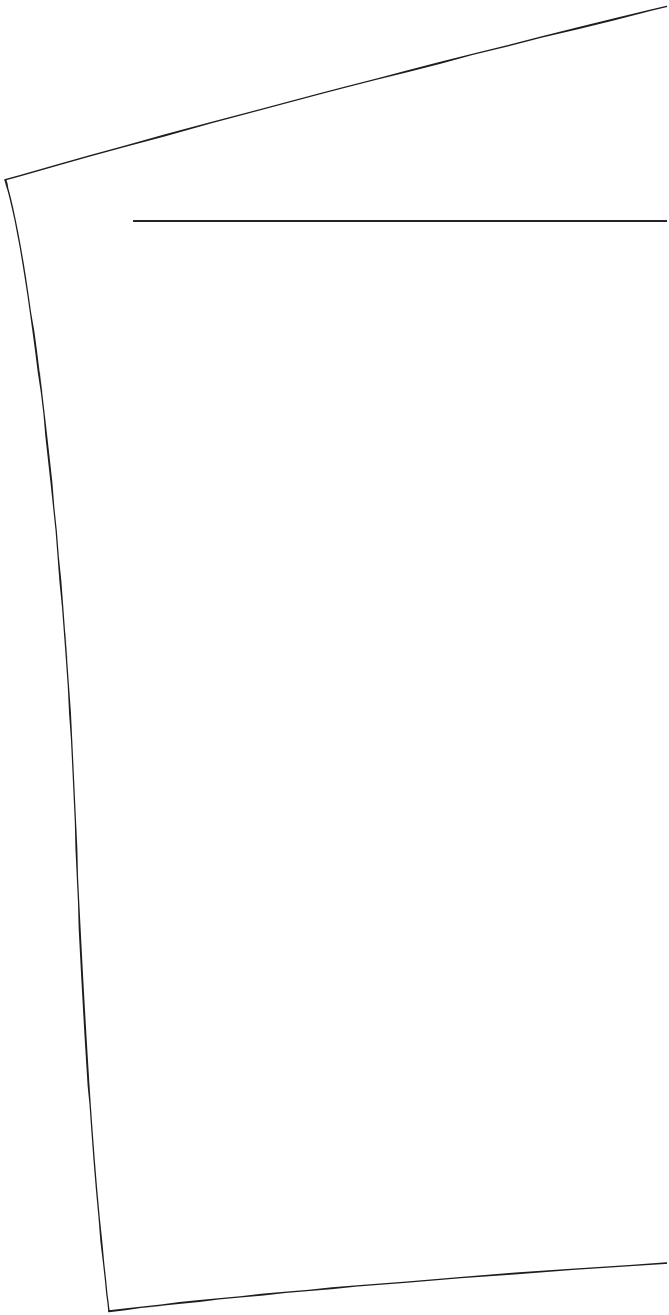

T

T



(3, 4)

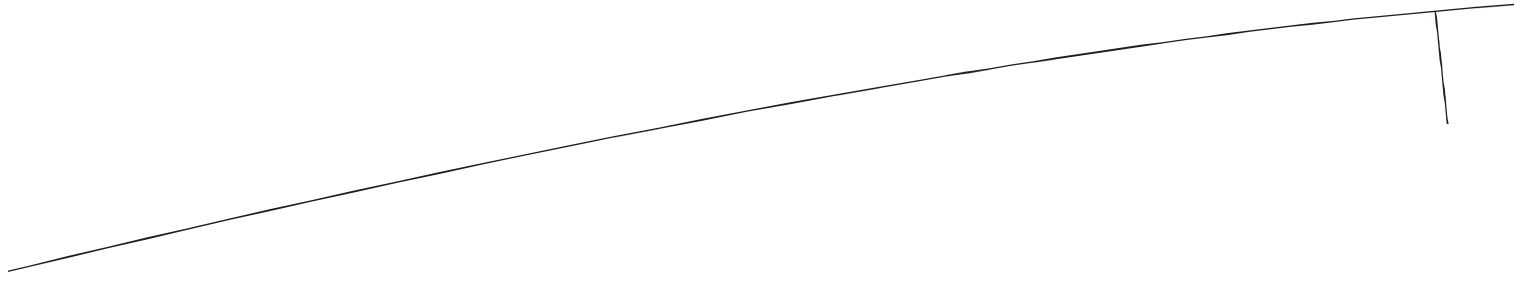

**Pa3mep 50**  
**<http://materials.tell4all.ru>**

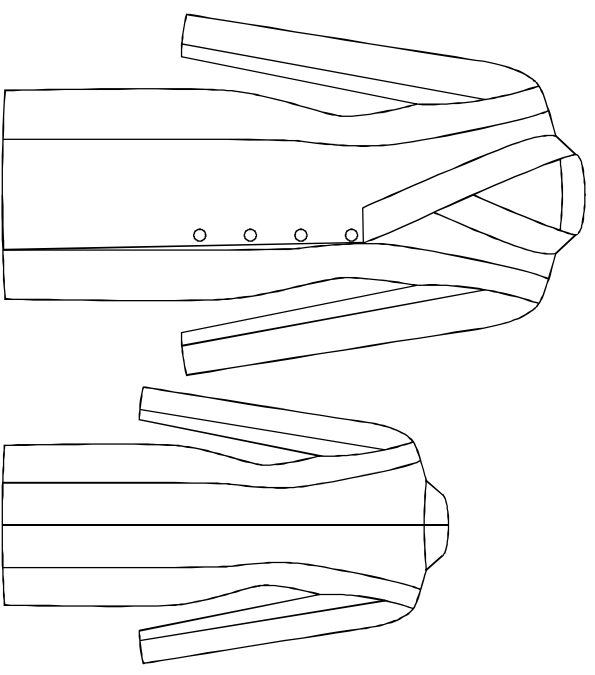

**Верхняя часть рукава**

**Нижняя часть рукава**

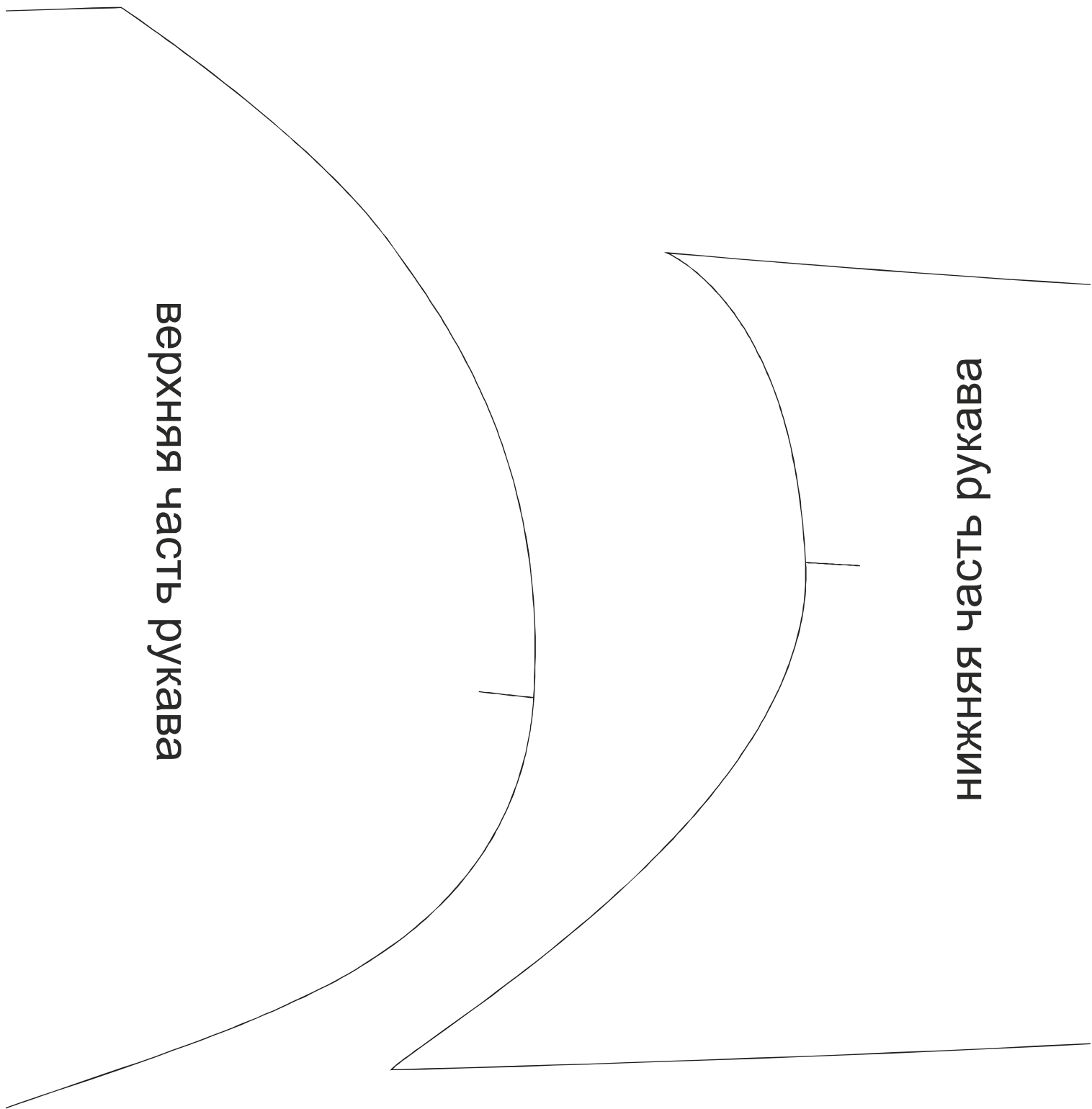

**Размер 50**  
**<http://materials.tell4all.ru>**

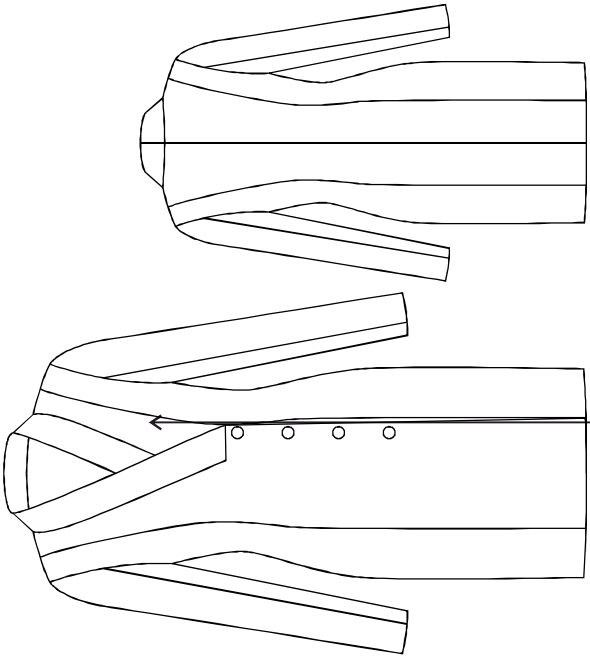

(7, 4)

