



Размер 58
 Соответствие размеров
 смотрите на сайте
 «Шкатулка»
<http://materials.tell4all.ru>

Автор выкройки: Анна Ивина

Файл с выкройкой и все его фрагменты охраняются
 законом об авторском праве. Публикация и распространение
 выкройки и ее фрагментов запрещены!

Официальное разрешение предоставлено только следующим
 сайтам:

<http://materials.tell4all.ru>

Если Вы обнаружили нарушение авторских прав,
 необходимо сообщить об этом по адресу admin@tell4all.ru

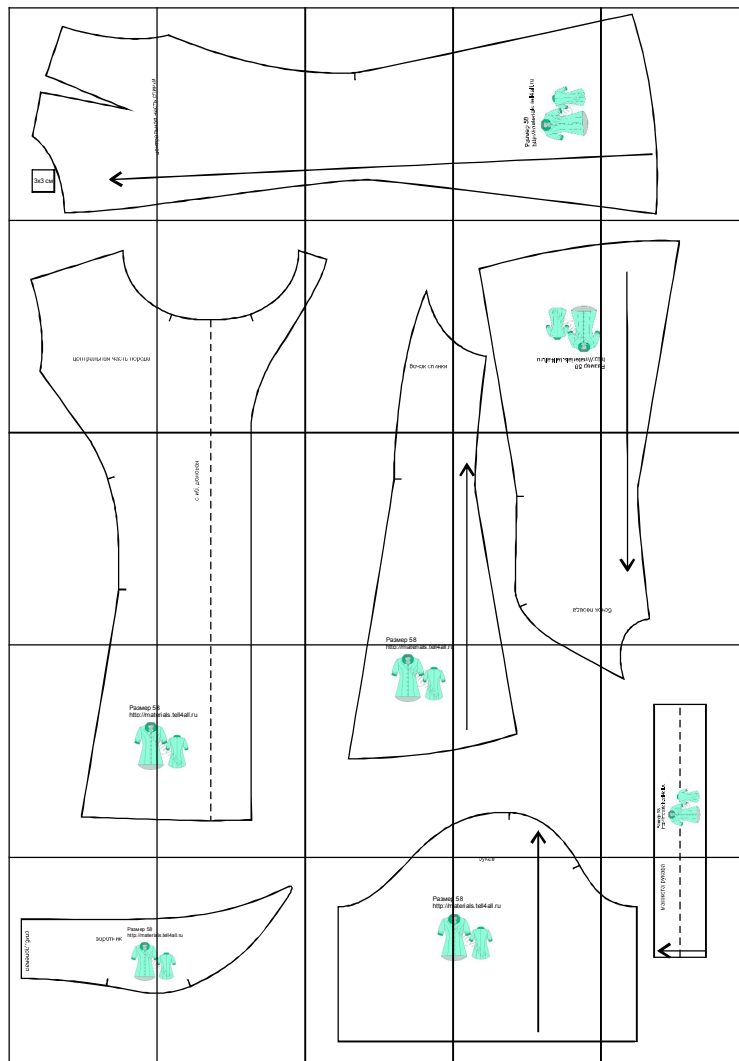

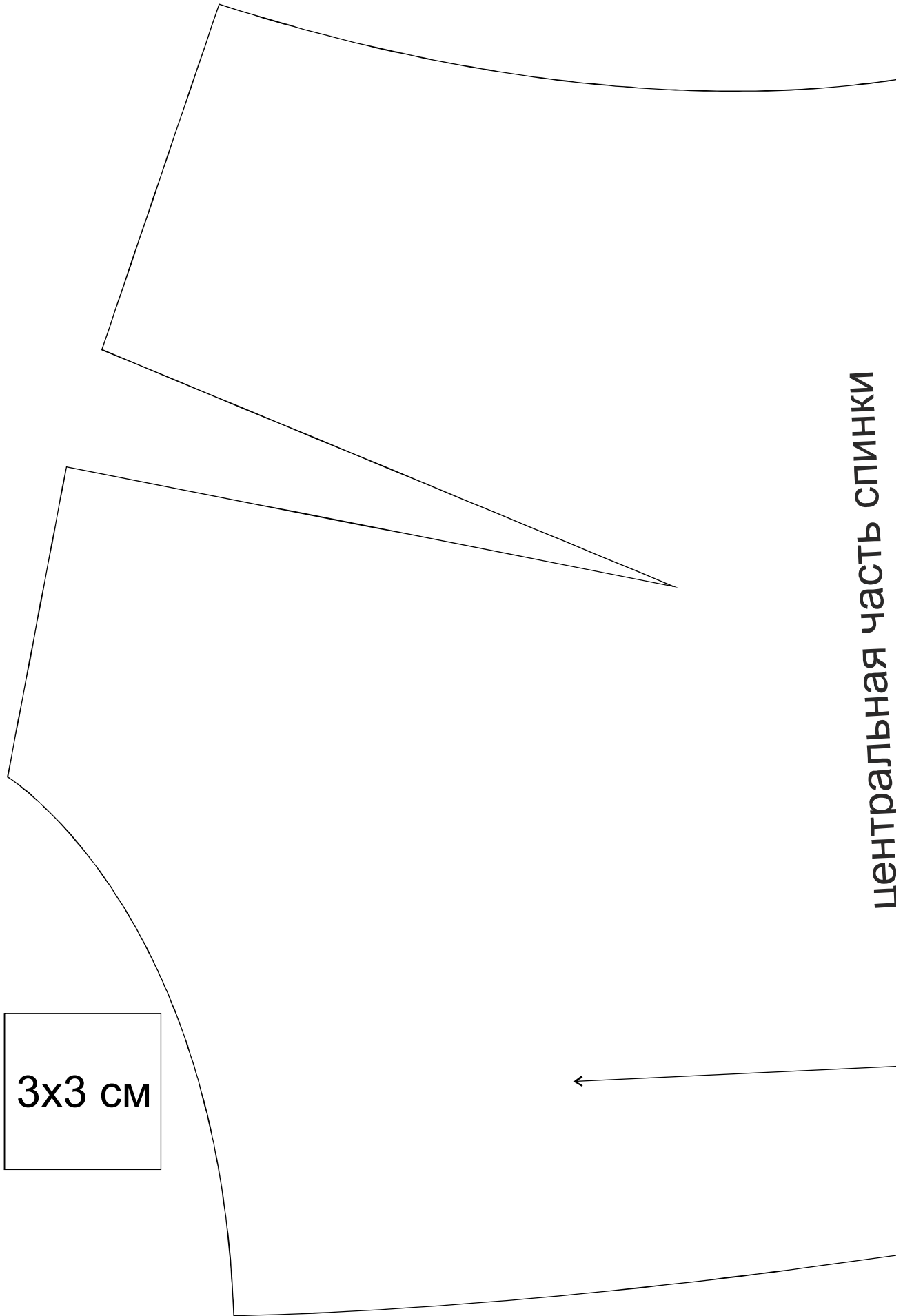

3x3 см

центральная часть спинки

(2, 1)

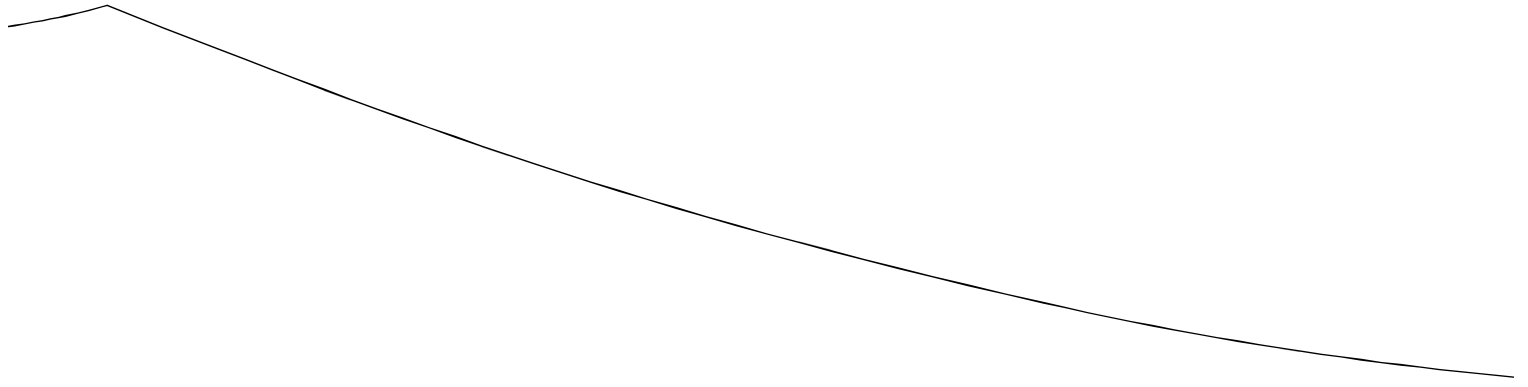

•

┌

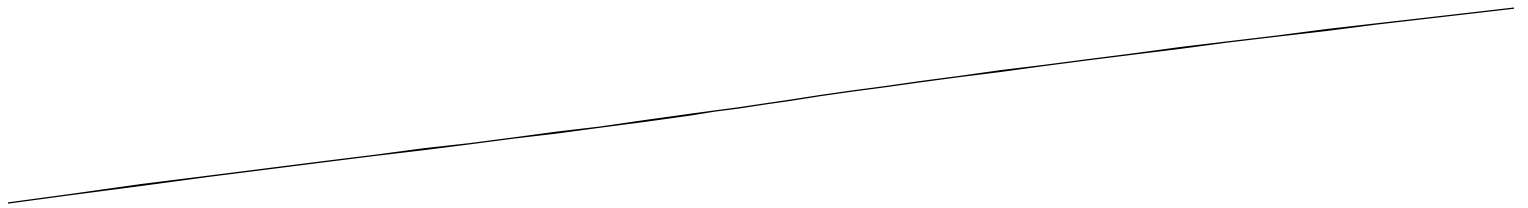

+

+

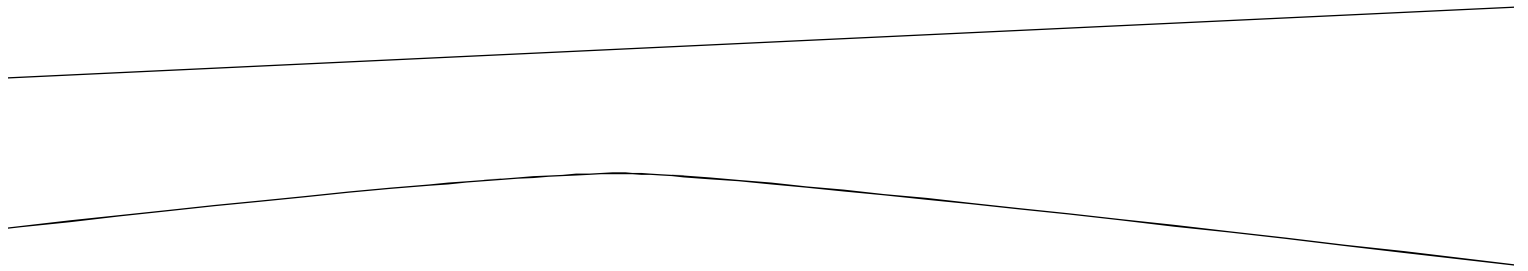
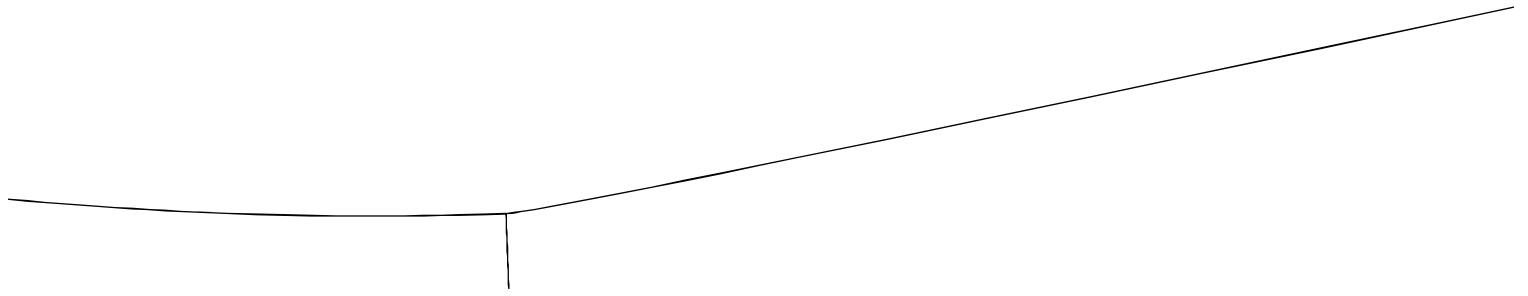

Размер 58
<http://materials.tell4all.ru>

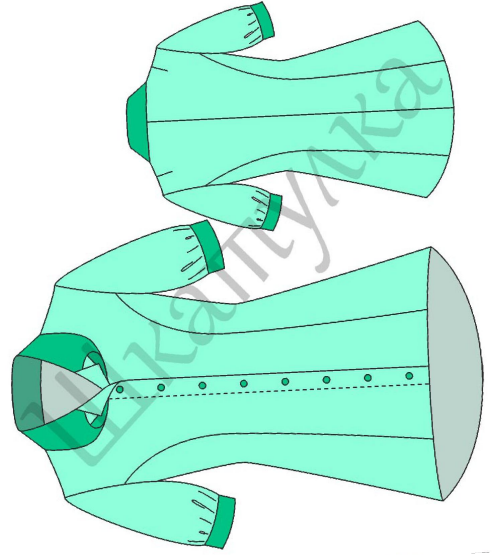

(5, 1)

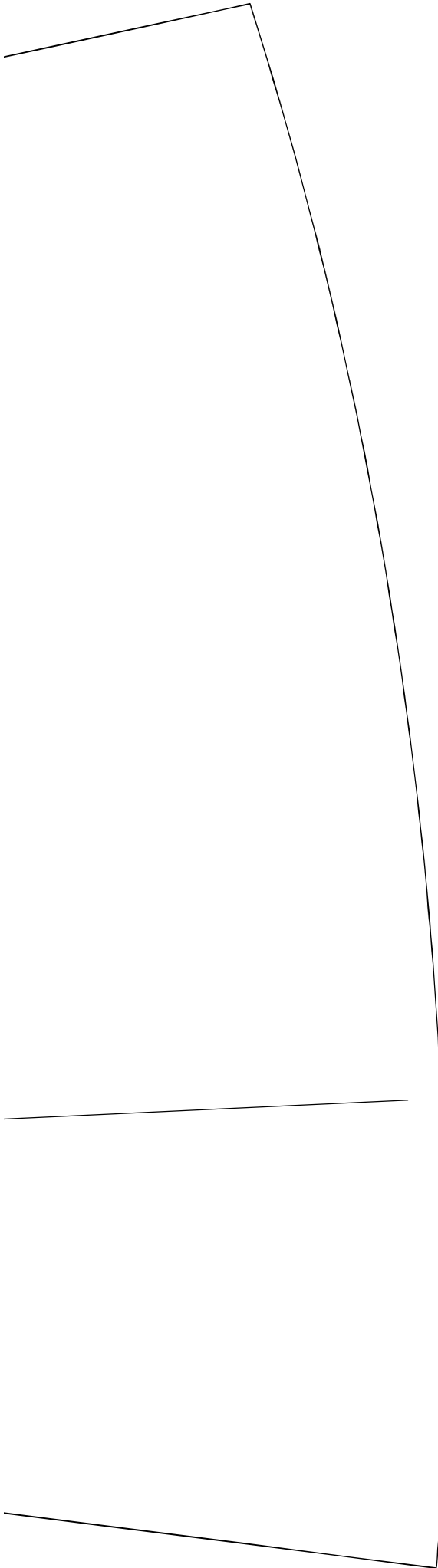

+

+



центральная часть перед

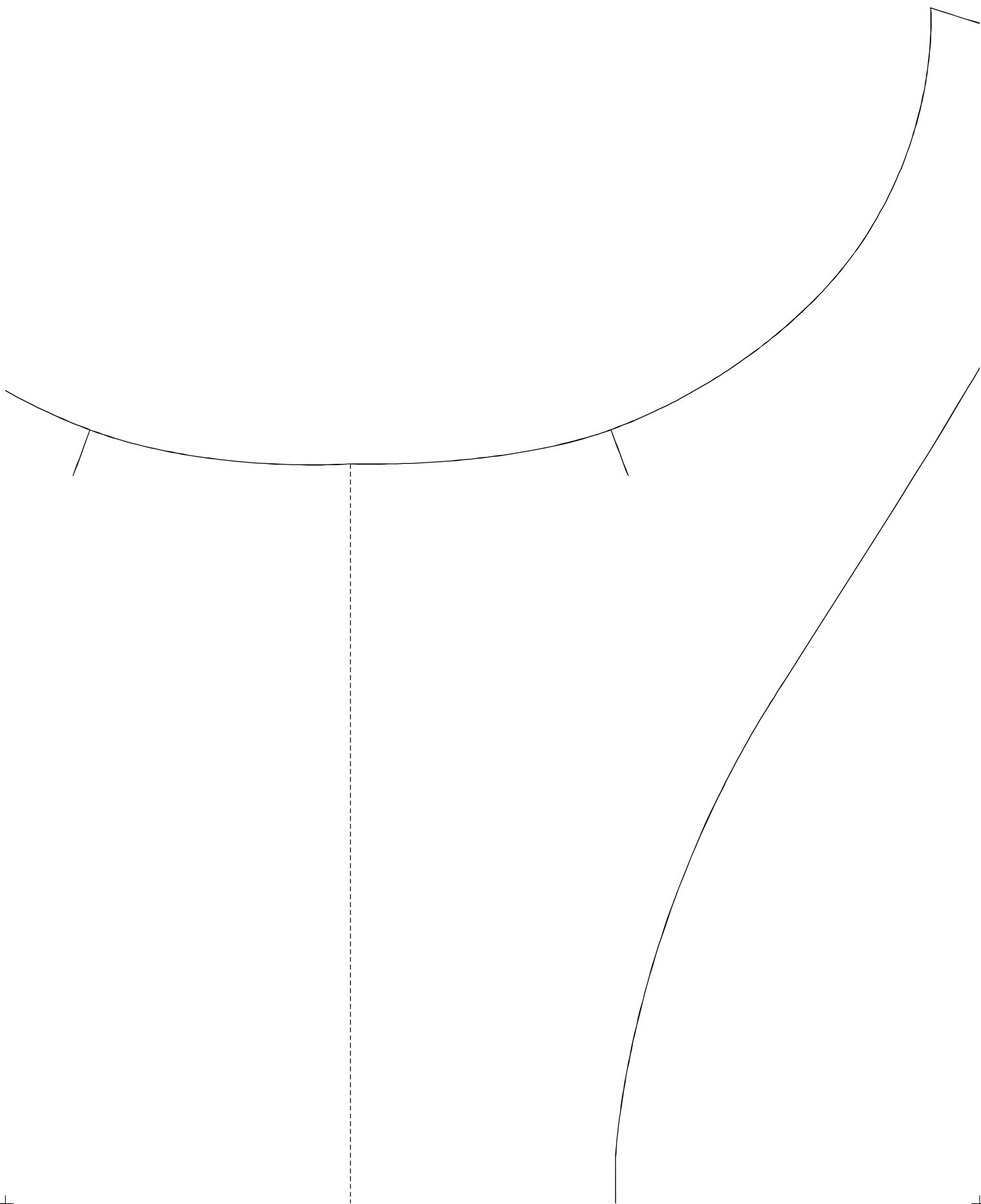

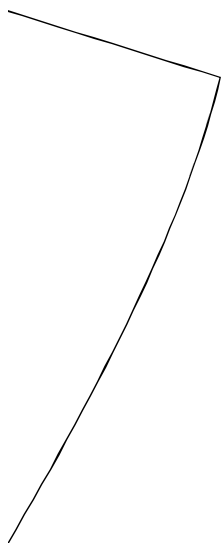

БОЧОК СПИНКИ

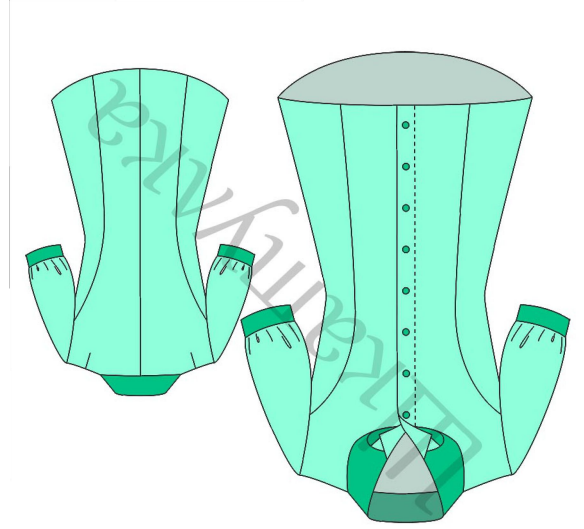
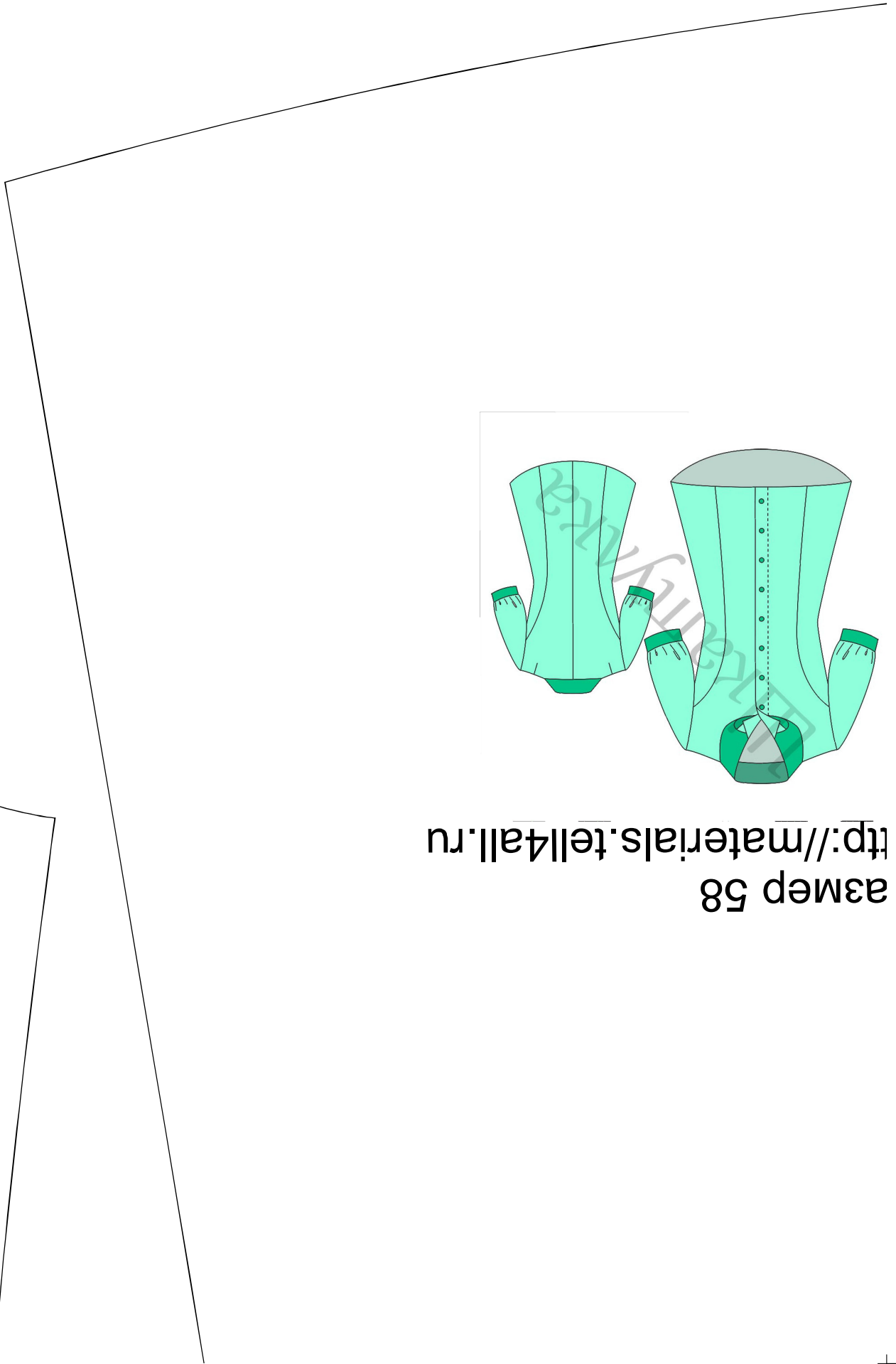

аэмер 58
<http://materials.tell4all.ru>

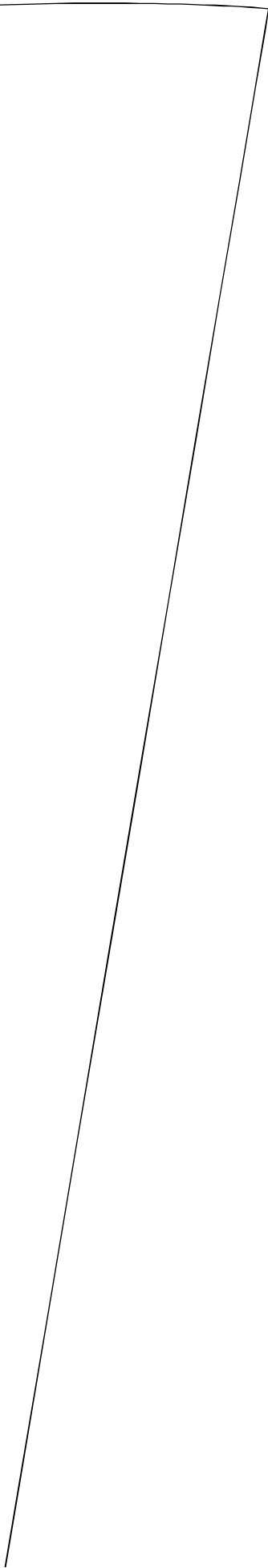

0.5



— (1, 3)

+

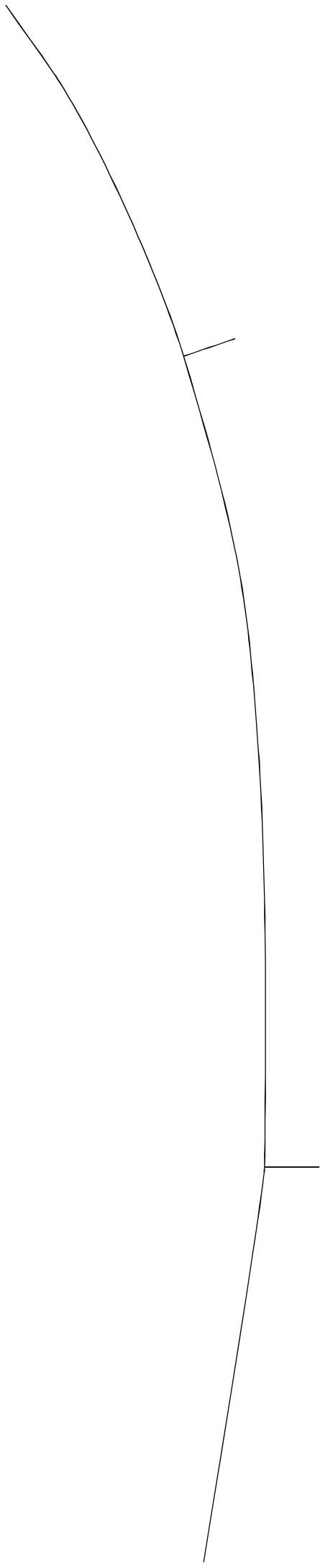

—

+

сгиб, долевая

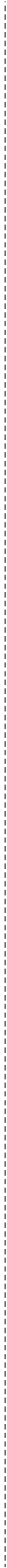

(3, 3)

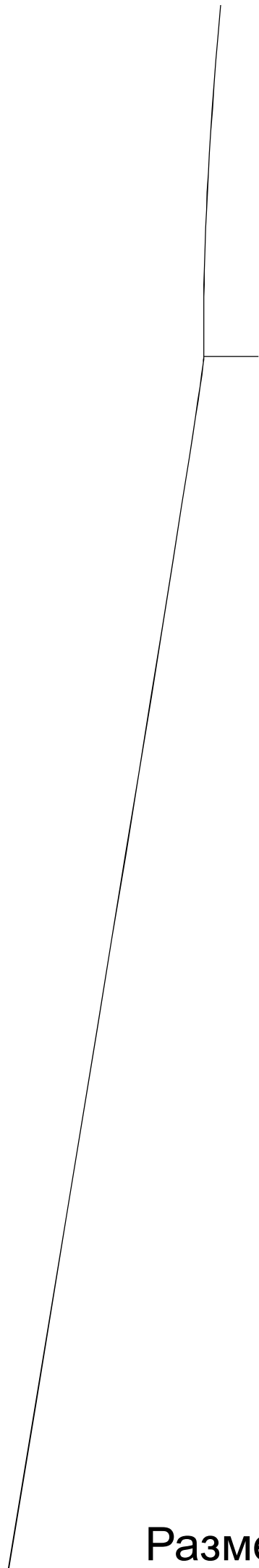

Размер 58

(4, 3)



OK перета

(5, 3)

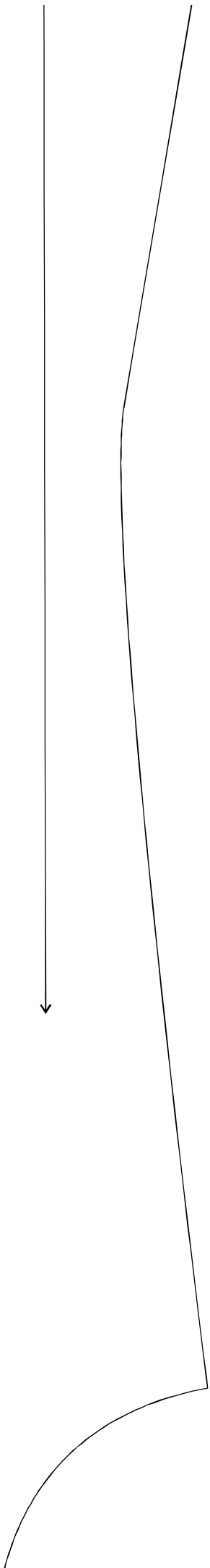

h09

Размер 58
<http://mate>

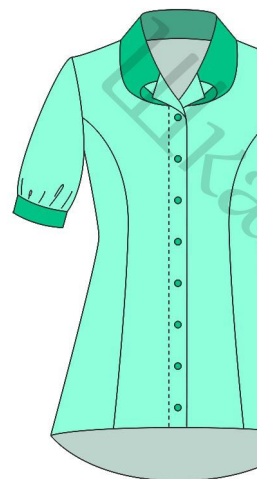

rials.tell4all.ru





(4, 4)

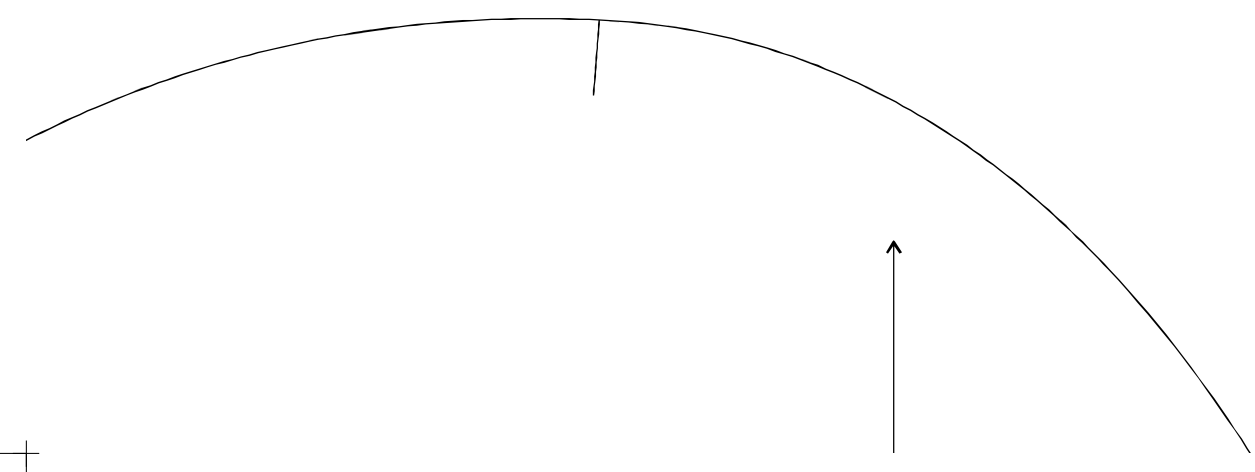
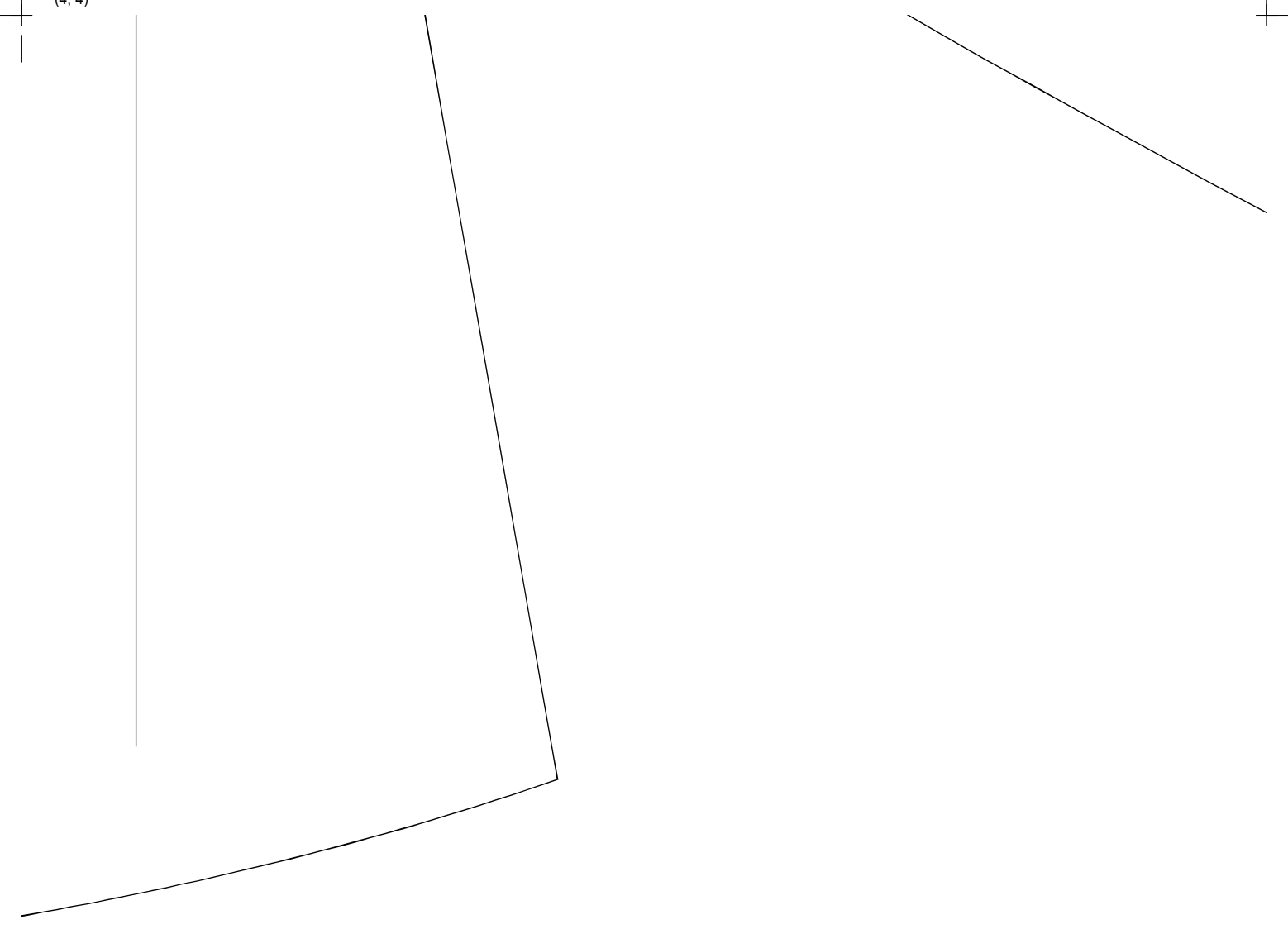

Размер 58
<http://materials.tell4all.ru>

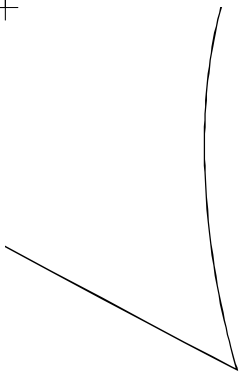
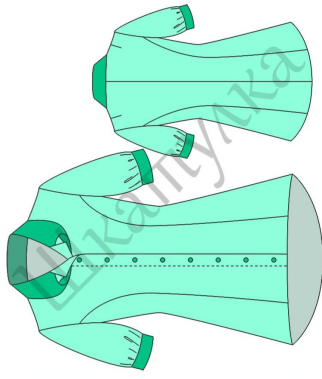

сгиб, долевая

воротник

Размер 58
<http://material>





s.tell4all.ru



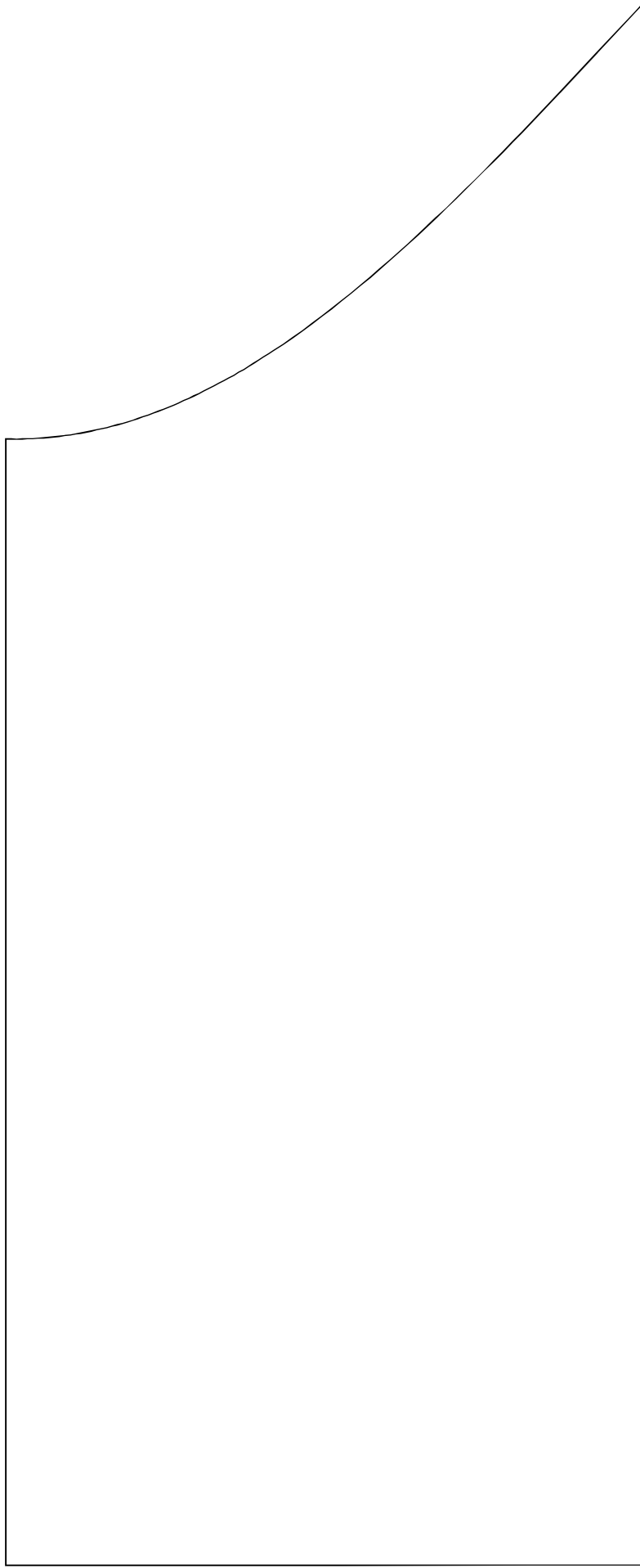

Размер
<http://m>

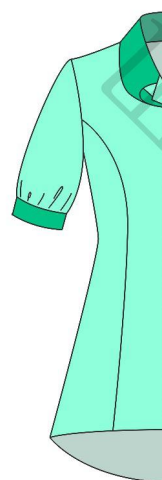

рукав

58

materials.tell4all.ru

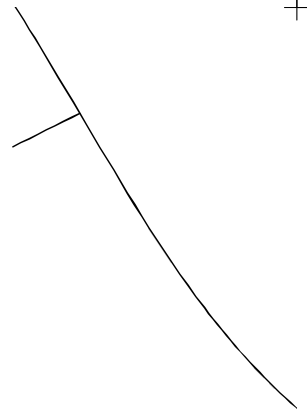



манжета рукава

