

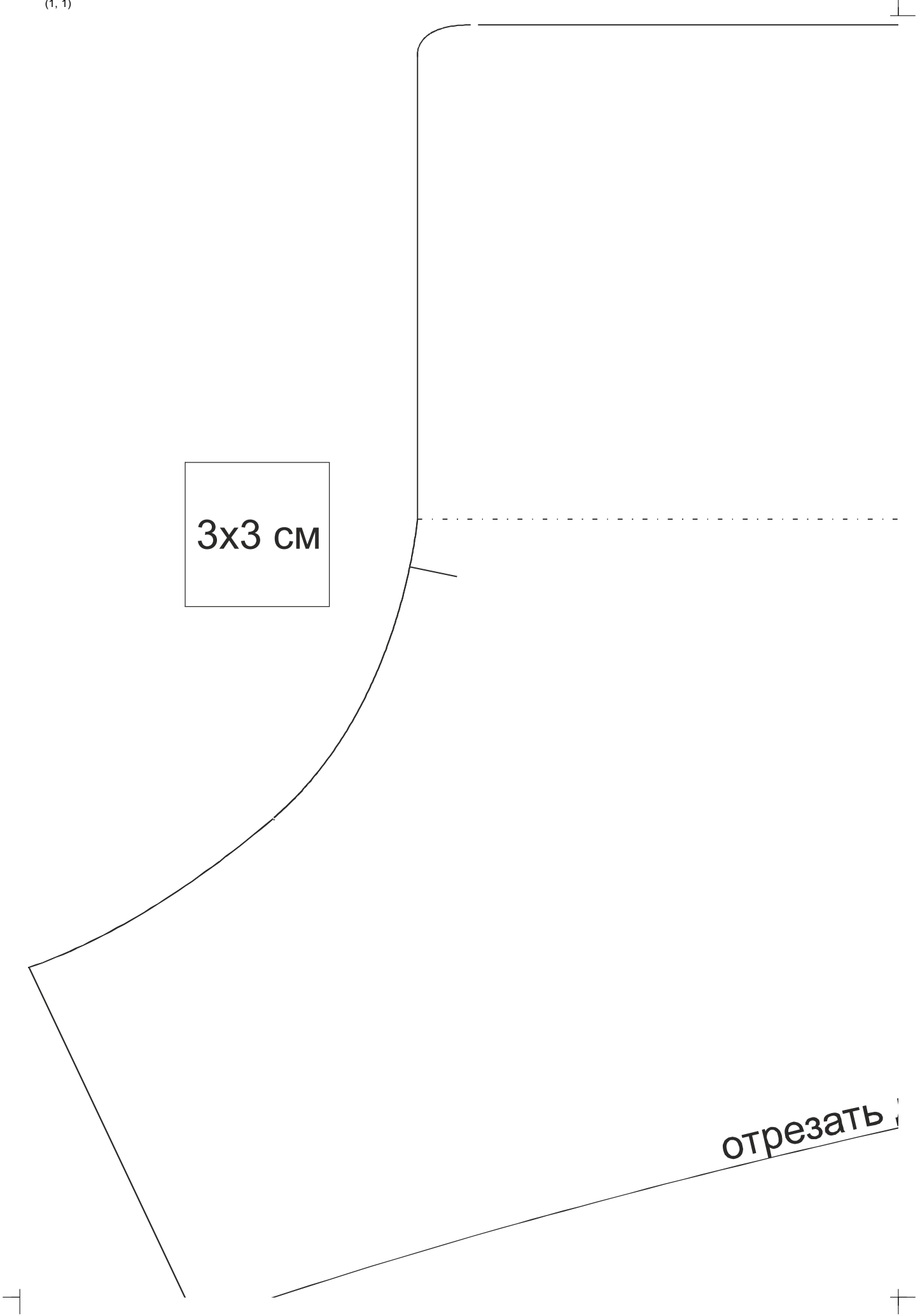

(1, 1)

3x3 см

отрезать



размер 44  
<http://materials.tell4all.ru>

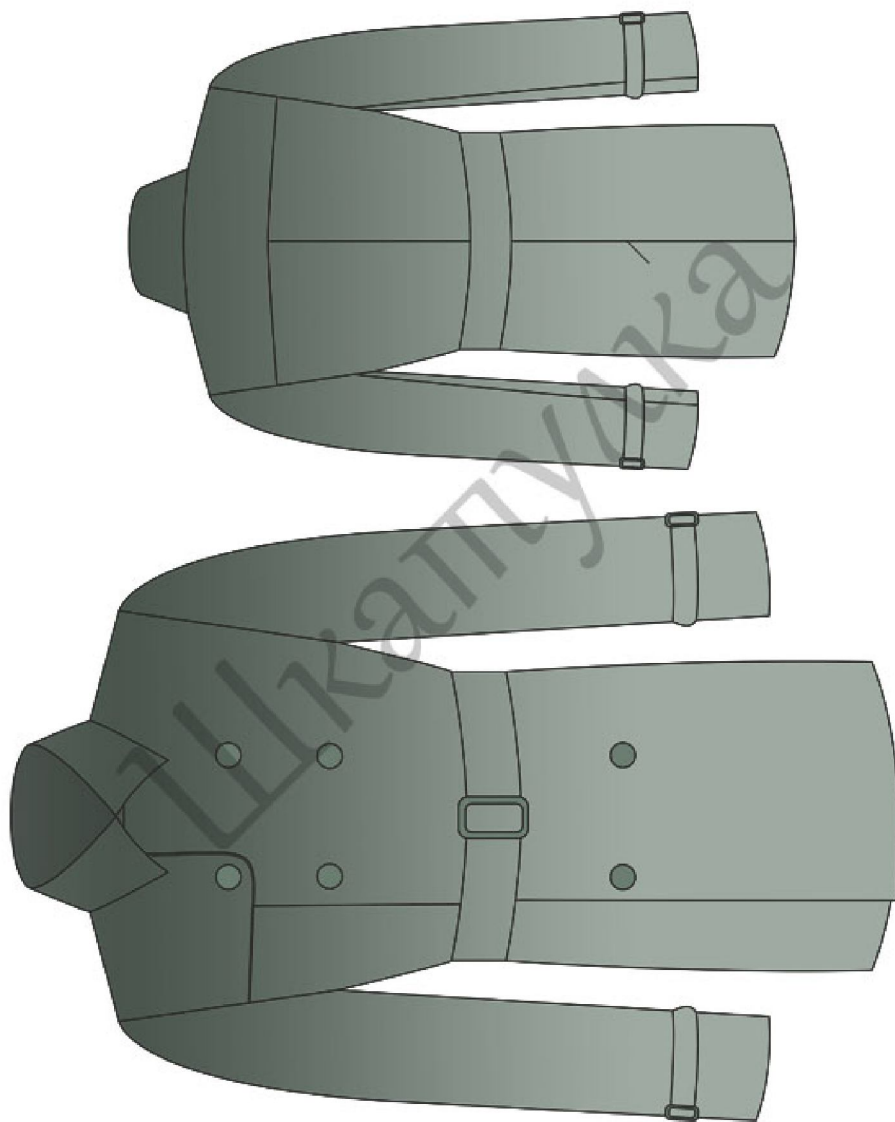

для лекала подборта

(3, 1)



(4, 1)



(5, 1)

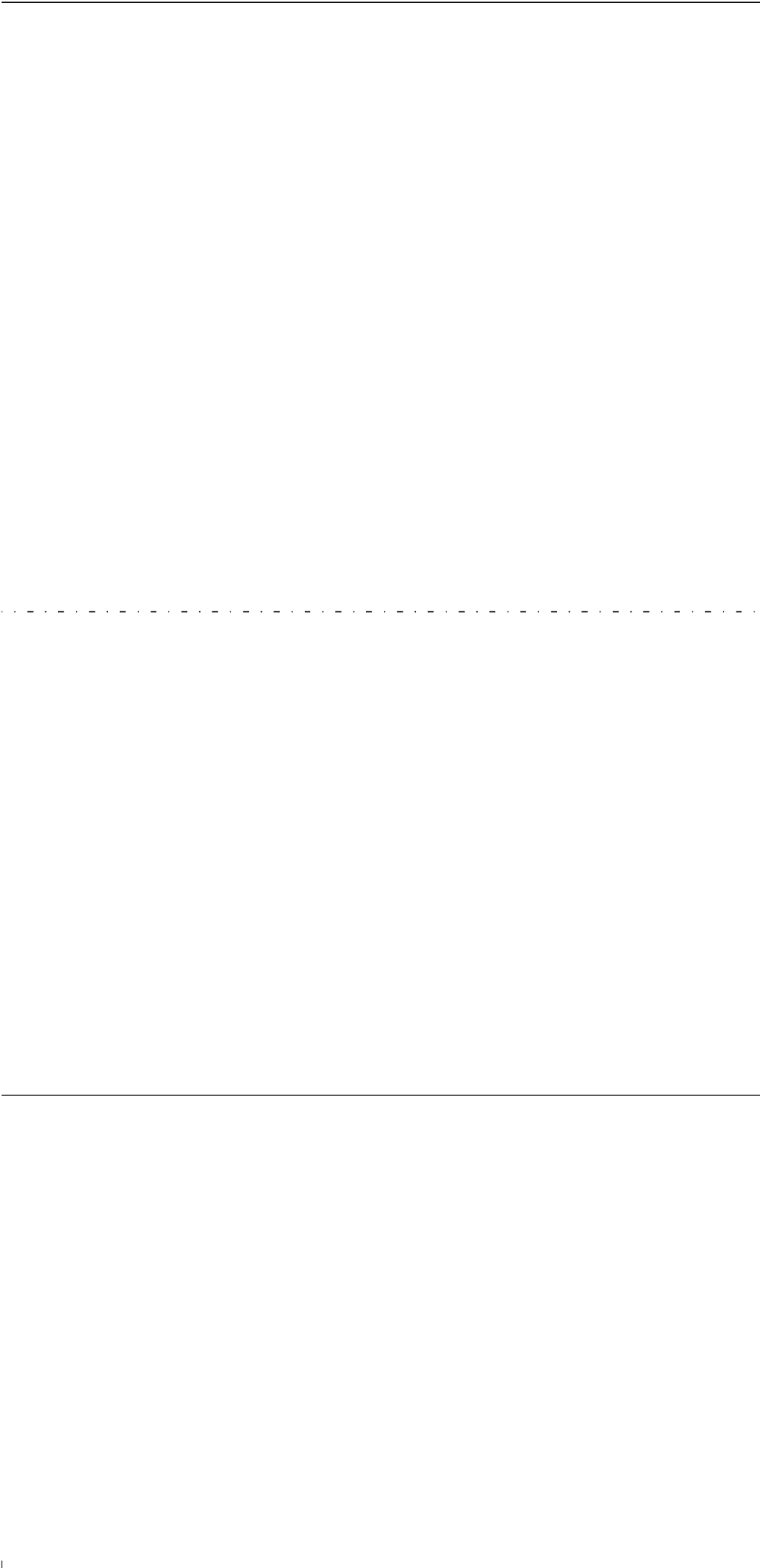

T

— | (1, 2)

+

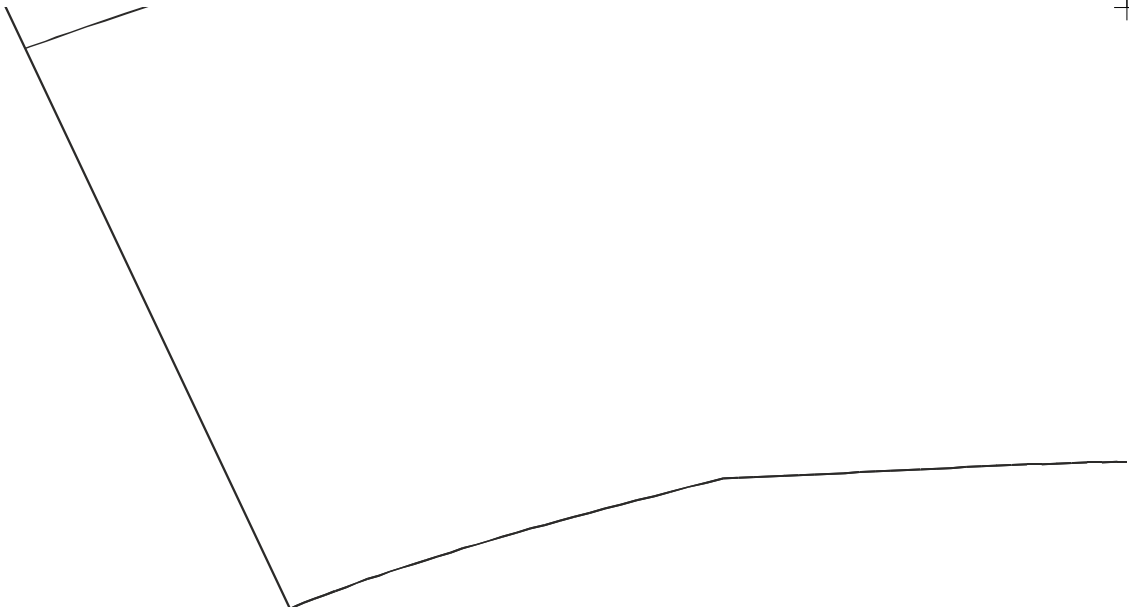

— |

+

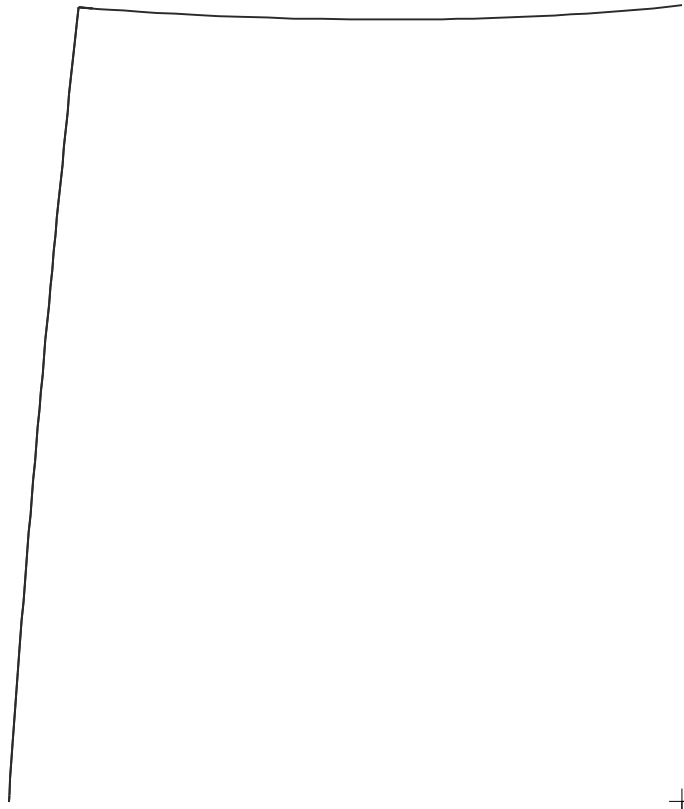

Is.tell4all.ru

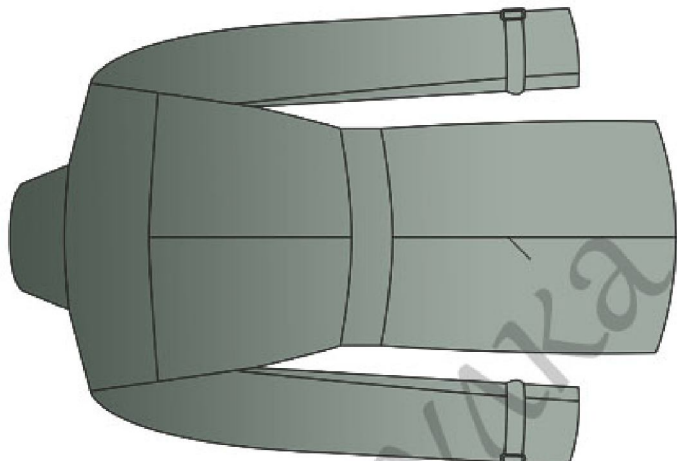

ПОЛОЧКА

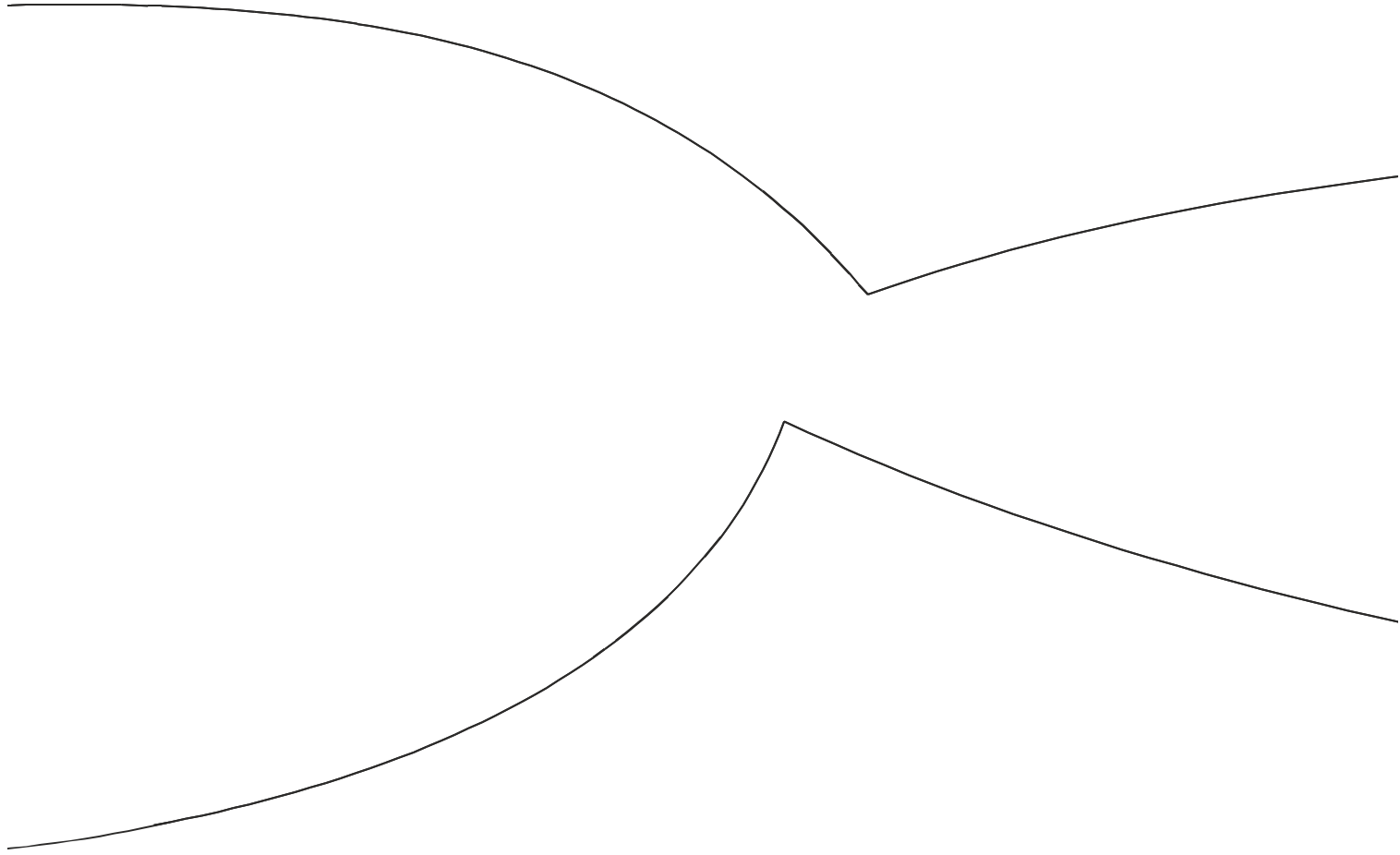





(4, 2)



(5, 2)



T

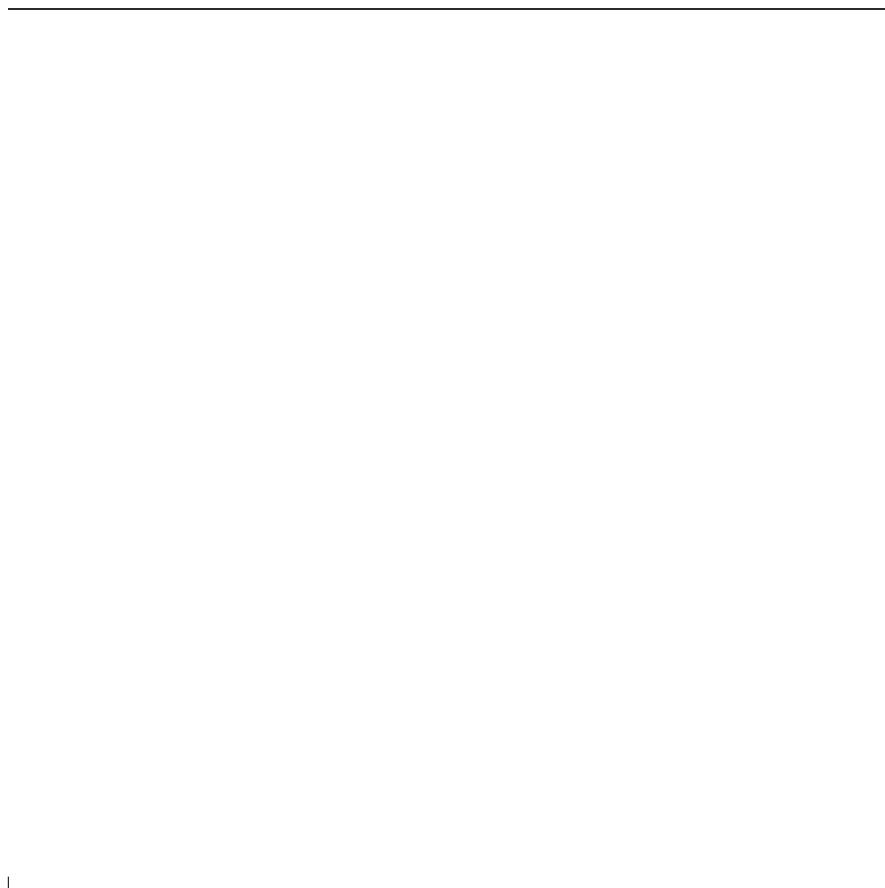

T

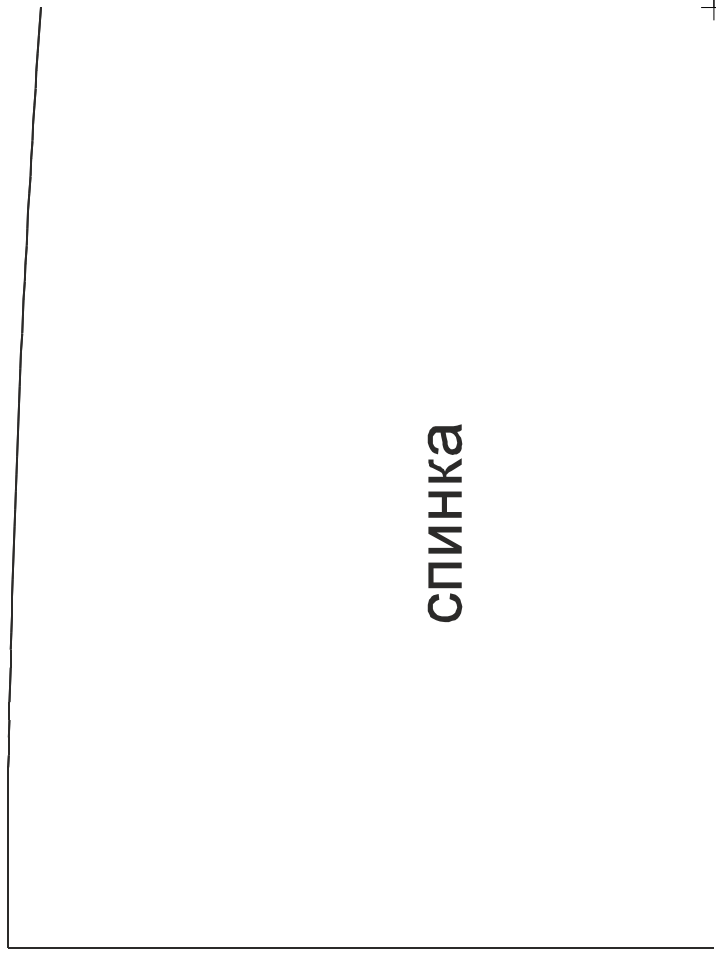

СПИНКА

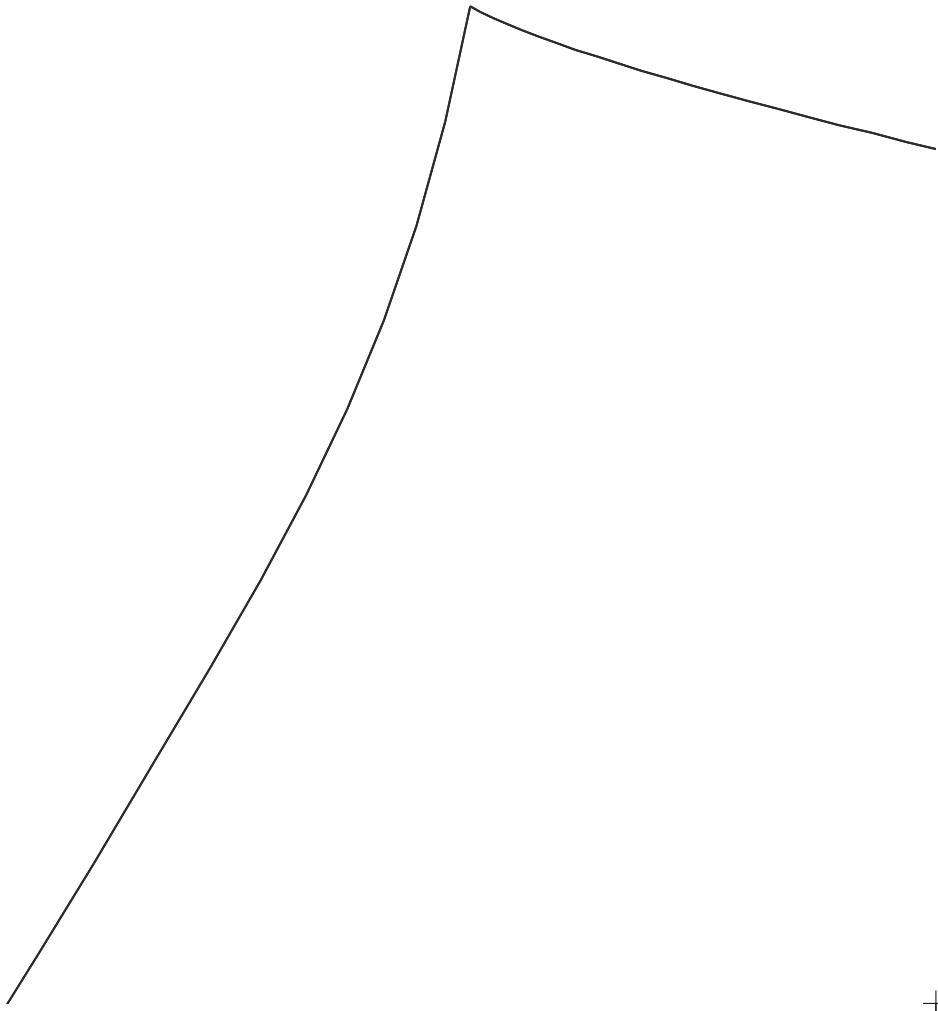

размер 44  
<http://material>

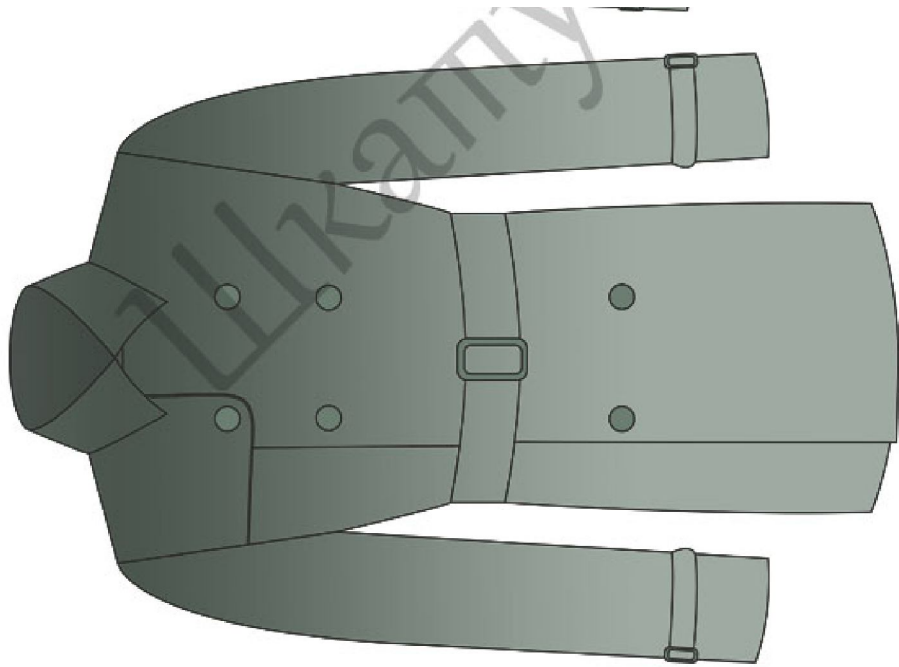

(3, 3)

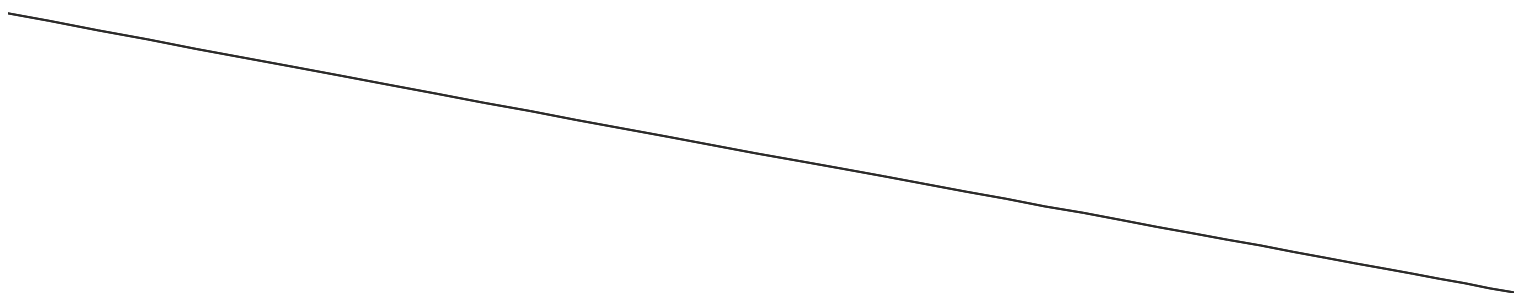

(4, 3)

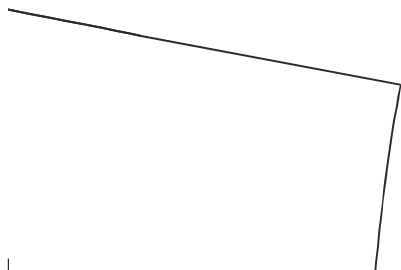
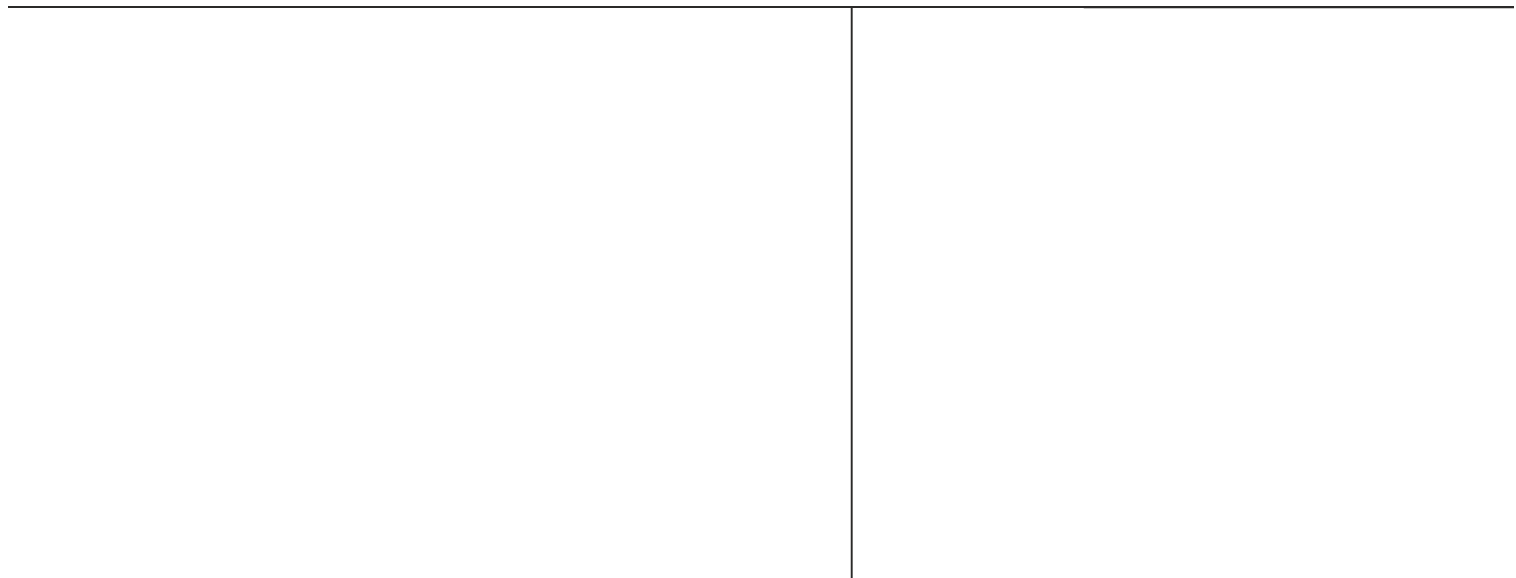

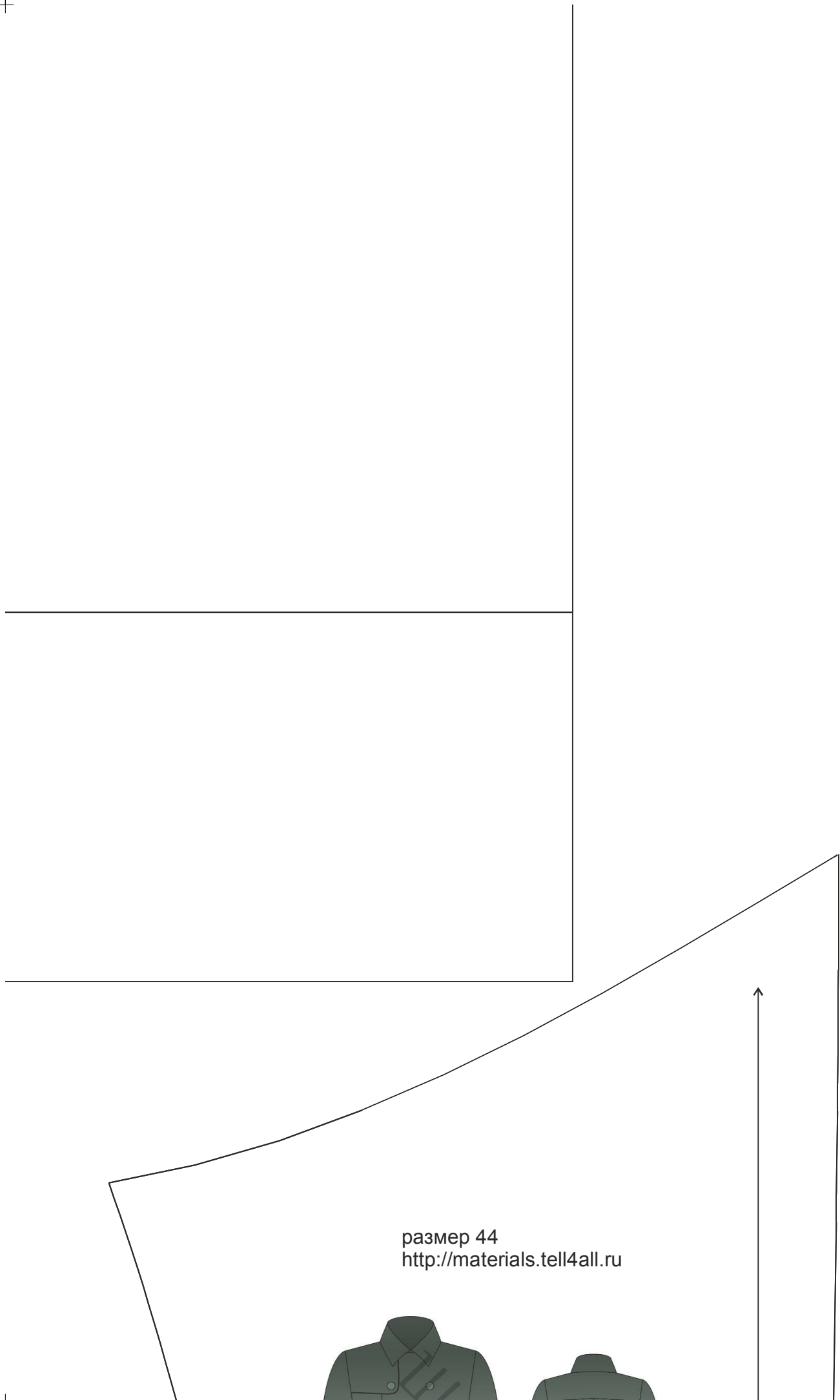

размер 44  
<http://materials.tell4all.ru>







(1, 4)

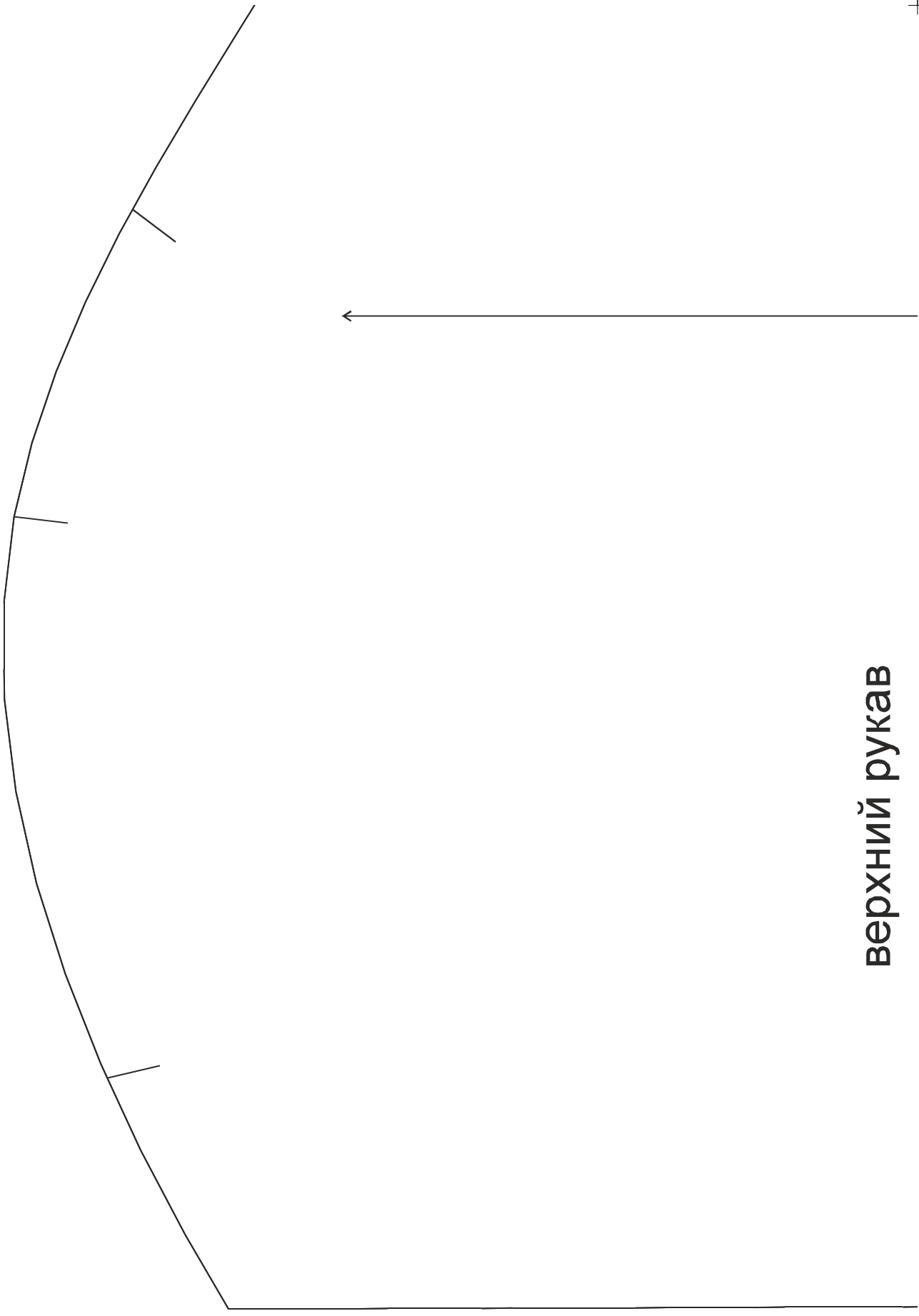

**верхний рукав**



размер 44  
<http://materials.tell4all.ru>

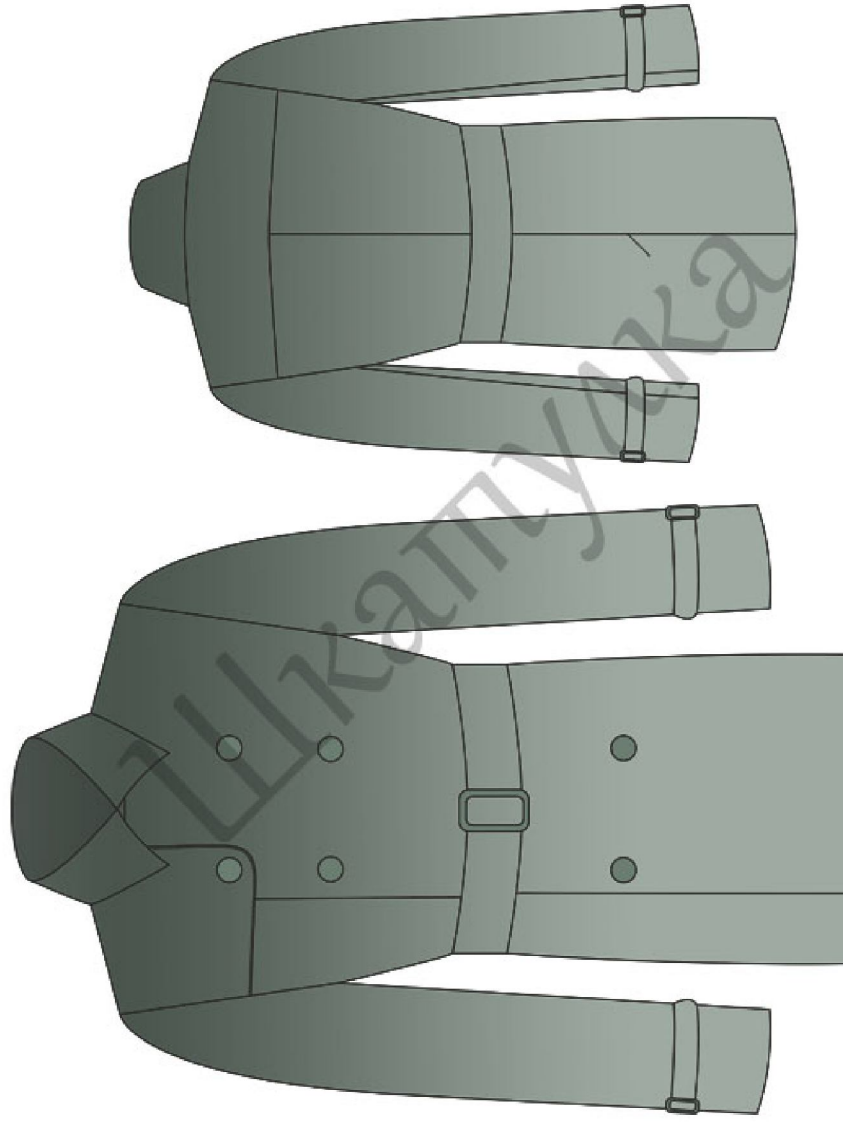



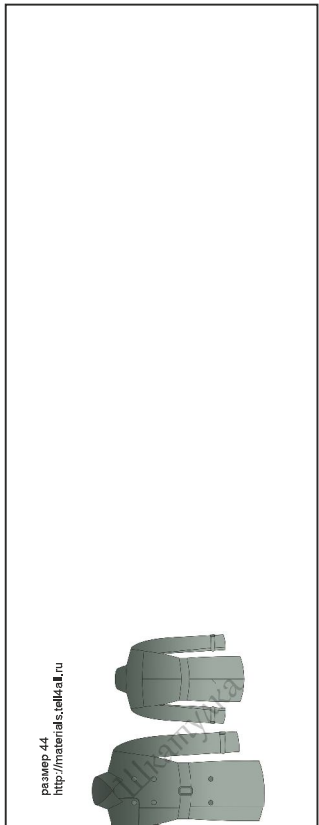
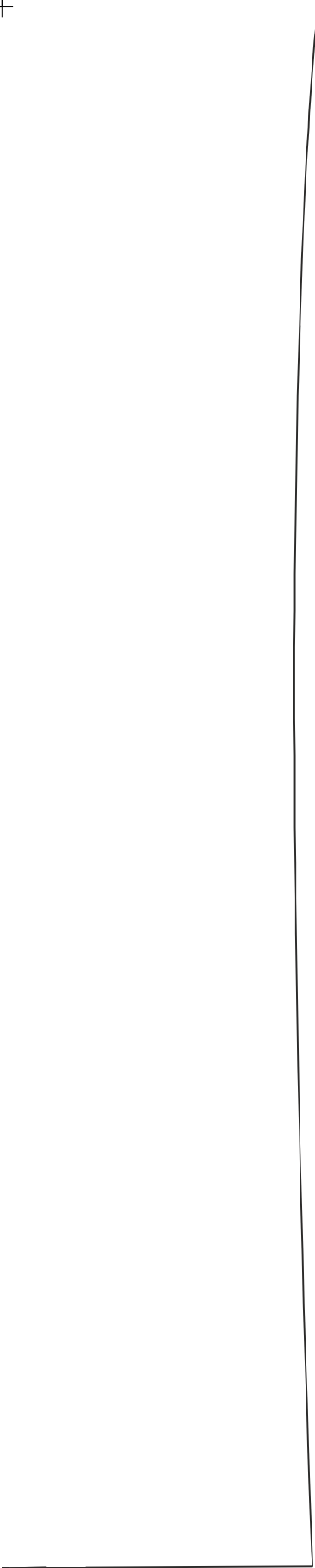

размер 44  
<http://materials.valka.ru>

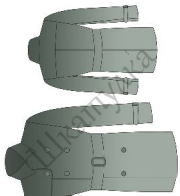



нижний рукав

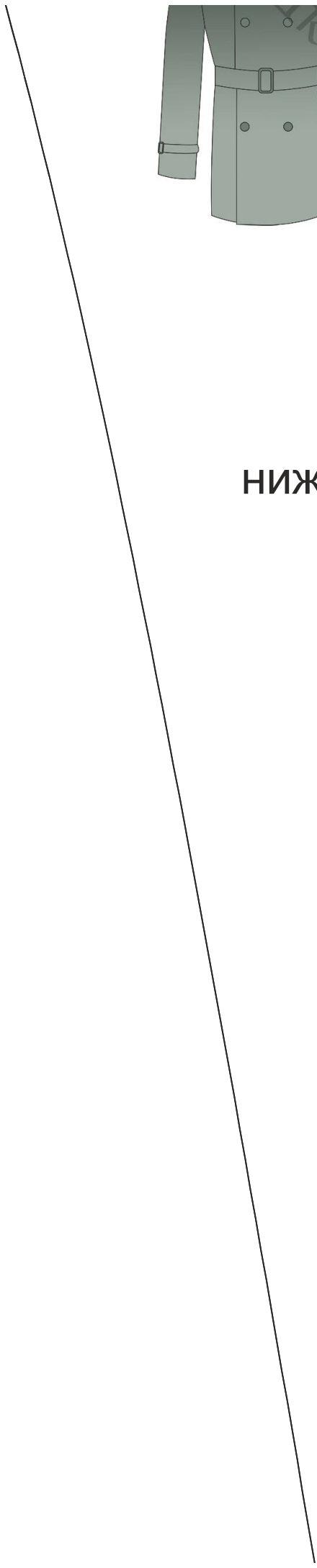

размер 44  
<http://materials.tell4all.ru>



**КОКЕТКА ПОЛОЧКИ**

размер 44  
<http://materials.tell4all.ru>

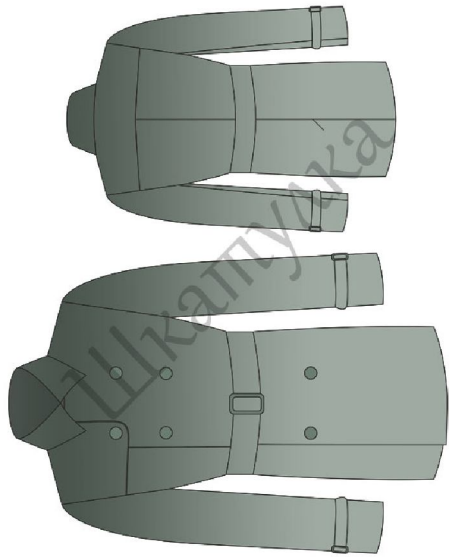

## ВОРОТНИК

сгиб, долевая

размер 44  
<http://materials.tell4all.ru>

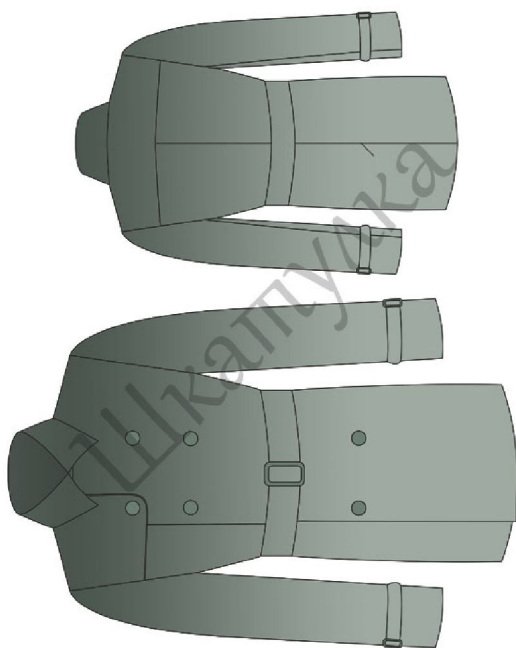

**КОКЕТКА СПИНКИ**

сгиб, долевая



ХЛЯСТИК РУКАВА



(5, 5)

